



User Manual
Asset Tracking
to
Milestone VMS Integration

| | |
|--|----|
| Overview | 3 |
| Introduction | 3 |
| <i>Critical features include:</i> | 4 |
| Installation | 5 |
| Pre-install requirements | 5 |
| Installation Process..... | 6 |
| C2P Base | 6 |
| Installing the C2P Base..... | 6 |
| Installing the C2P ASSET TRACKING Proxy | 10 |
| Configuration | 11 |
| C2P ASSET TRACKING Proxy configuration GUI | 11 |
| C2P Event Streaming Engine (ESE) GUI..... | 15 |
| C2P HSE Proxy GUI | 17 |
| Smart Client view setup for C2P integration | 18 |
| Troubleshooting..... | 19 |
| Appendix A: Sample C2P ASSET TRACKING proxy log files..... | 21 |
| Appendix B: C2P ASSET TRACKING GUI Rules Engine..... | 23 |
| Appendix C: CTP License Server Control Panel | 24 |
| Loading a new CTP License File..... | 25 |
| Appendix D: C2P Asset Tracking Settings Configuration Panel..... | 25 |
| Appendix E: Milestone Enterprise, Professional and Express setup | 27 |
| Appendix F: Universal Camera Setup using Plus Series Platform..... | 32 |
| Contact Information | 42 |

Overview

This User manual is intended to be used as a reference. This manual covers all of the components used in the C2P Asset Tracking integration with Milestone. A large portion of this manual covers the configuration of Milestone components as well as the C2P components.

The C2P portion of this integration can be installed in minutes and in many cases will work as shipped without any configuration needed. This manual serves as a reference for applications that go beyond a basic install of the C2P ASSET TRACKING to Milestone integration.

Introduction

ConvergenceTP (C2P) is the market leader in bringing text and alert information from virtually any TCP/IP enabled appliance or sensor into the users Milestone Video Management System (VMS). Video surveillance is a powerful tool for security professionals, but the true benefits of video surveillance can only be realized when users have access to the data (all the data) from every TCP/IP enabled device in the customer enterprise. This Internet of Things (IoT) concept is the basis for the C2P middleware that connects the users VMS to their TCP/IP enabled devices.

The value for the user when their IP appliance and sensor data is captured and stored time synchronized with the video in the video surveillance system is they now have a way to index video in their surveillance system. With the C2P Hypermedia Search Engine (HSE) users can search on text received from a Point of sale terminal, License plate reader, Access control reader, Bar code reader, RFID sensor, etc. and then watch video of that specific event as it happened. Having the data time synchronized with the surveillance video means users can then bring up a view from any camera in their video surveillance enterprise and follow the person or object of interest as it moves out of view of one camera and into view of another.

Users can also setup the easy to use C2P real-time Rules Engine which allows them to flag specific events for immediate viewing, or push user defined procedures for that specific event to the VMS operator's screen. The Rules engine also allows the user to push generic events to the VMS system to synchronize, annotate and bookmark the detected event within the VMS event database.

Critical features include:

- *ASSET TRACKING text captured by C2P is time synchronized with any and all video cameras attached to the Milestone VMS.*
- *ASSET TRACKING text can be viewed in real-time from any Milestone Smart Client.*
- *All ASSET TRACKING text received is stored and therefore available for future back office forensics searches.*
- *C2P provides an intuitive and powerful Hypermedia Search Engine (HSE) for use in researching specific events.*
- *HSE search results provide the full text of the events that are linked to the actual Milestone stored video of the event.*
- *C2P provides many real-time analytic tools that users can setup to trigger on specific events of interest.*

The screenshot displays the Milestone XProtect Smart Client 2016 R2 interface. The main window is titled "Hypermedia Search™" and contains a search form with the following fields:

- Search Type: MFG
- From: 09/06/2016 23:59
- To: 09/07/2016 23:59
- Spreadsheet Fields: Inspection Point, SKU, Description
- Buttons: Add Parameter, Spreadsheet, Add a Field, Download, View

Below the search form is a table of search results:

| View Event | Date | Inspection Point | SKU | Description |
|---|-------------------|------------------|--------------|---|
| Show Cameras Expand | 16:31:58 9/7/2016 | Receiving dock1 | 23A45B67Dx24 | Campbells Healthy request cream chicken |
| Show Cameras Expand | 16:31:48 9/7/2016 | Receiving dock3 | 42A63B59Dx24 | Campbells Spicy chicken |

At the bottom of the interface is a video player showing a worker at a receiving dock. The video player includes a timeline and playback controls.

Installation

For new installations you will need both the C2P Asset Tracking driver installer as well as the C2P Milestone System Installer. Shown below is the barcode reader installer but can just as well be the DHL, SEUR Barcode or a generic manufacturing barcode installer.

Note: included in the C2P / Milestone System installer is the HSE, HSE Proxy, ESE and License server.

Included in the Asset Tracking installer is the Asset Tracking driver and the ESE.

Typical C2P Asset Tracker /Barcode Reader Deployment

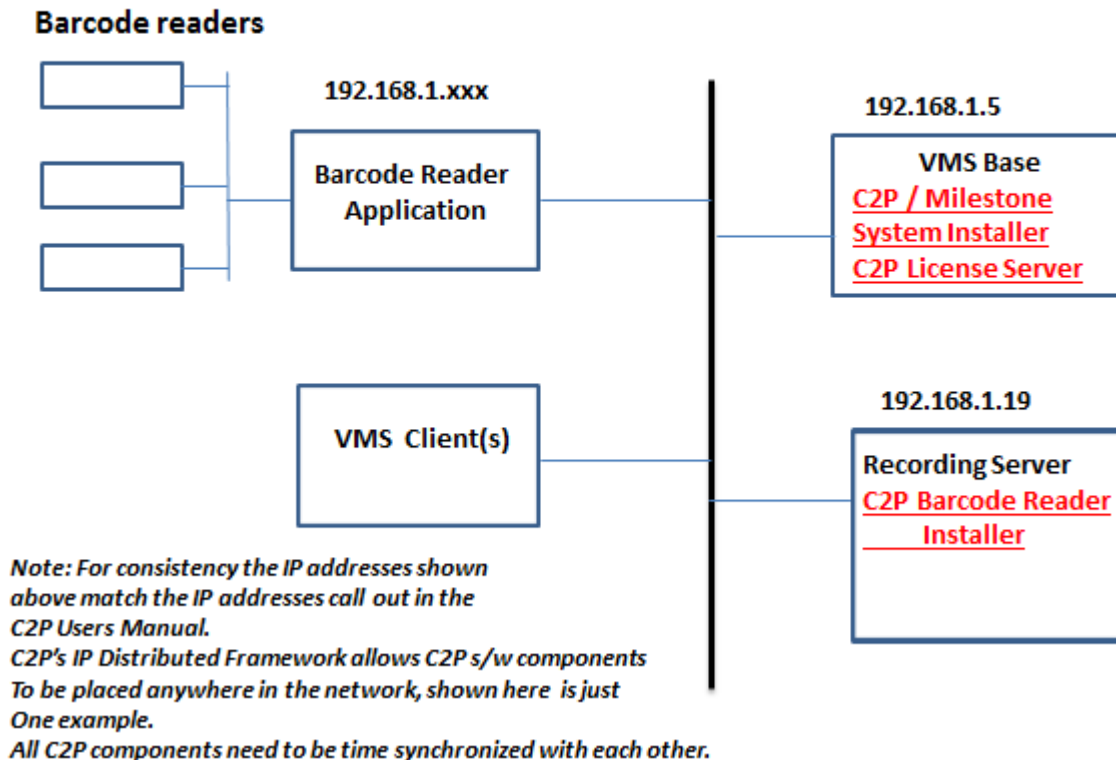

Figure 1 below depicts a typical C2P ASSET TRACKING deployment topology.

Figure 1

Note:

For evaluation and demo applications all of the components listed above can be installed on the same system. Without any further configuration required.

Pre-install requirements

The PC/server used to host any of the C2P Base components needs to have i7 class processor min.¹
Microsoft Windows® operating system Win 7/Server 2008 or Win 8/Server 2012²
The machine to be used for the install needs to be relatively current with Windows Updates.
Ensure that the PCs/servers used to host the ESE and HSE are time synchronized with the VMS.
During the install temporarily disable any antivirus SW and drop the local firewall.
Milestone Smart Client installed on the PC/Server hosting the C2P ASSET TRACKING Proxy software.
Internet Explorer 9 or above installed on any PC hosting Smart Client workstations
At least 1 Universal Camera license from Milestone is needed.
Defaults to 30 day demo on initial install.
Ability to temporarily set UAC to off while doing the install.
Smart Client “Basic” login account with valid credentials
Administrator account for use when installing CTP software
The machine hosting the HSE needs to only host the copy of Apache and MySQL installed by C2P.
No other copies of Apache or MySQL can be installed on the same machine that is hosting the C2P HSE.

Installation Process

C2P Base

Note: Installing C2P Base for the first time may require a restart of the machine after the install completes.

The C2P Base software installs all of the components needed for the C2P Base system.

These components include:

- The C2P Event Streaming Engine (ESE)
- The C2P Hypermedia Search Engine (HSE)
- The C2P Hypermedia Search Engine Proxy (HSE Proxy)
- The C2P License Server

Installing the C2P Base

1) Execute the C2P Base installer. “Run as administrator”

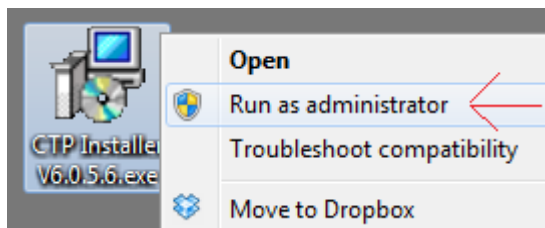
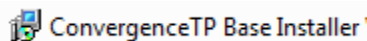

¹ The system requirements are the minimum of what will be required for satisfactory performance; your particular needs may differ or exceed the minimum requirements listed. Your specific needs will be dependent on several factors including number of IP appliances connected, number of users, the type of connected devices and the level of usage per device.

² If installing the C2P Real-Time charting or graphing package the OS needs to be 64-bit.

- 2) Follow the default selections during the C2P Base install
- 3) Select the features being installed. See: C2P HSE Database Server component selection menu. See Figure 1 above for a definition of where each component is to be installed.

Note1: You will need to run the C2P Milestone System installer on both the PC/server hosting the Milestone Base and the PC/Server hosting the recording server(s). Once the C2P base installer is run you can then select which component you want to install.

Note 2: For example as shown in Figure 1 the HSE database is installed on the same machine as the Milestone base = 192.168.1.5. Installing the CTP s/w components on the same machine will use the diagram below showing the two checked boxes.

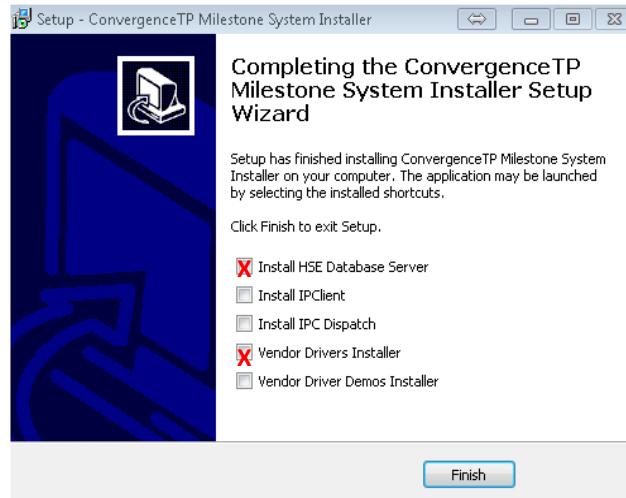

Note3: Installing the components on two different machines will use the diagram below showing one checked box on the server where the HSE Database is installed and one checked box where the Asset Tracking driver is installed.

Milestone Base

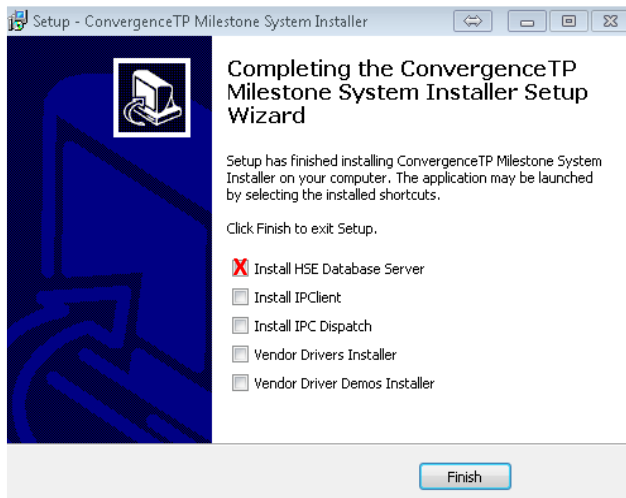

Recording Server (Asset Tracking driver)

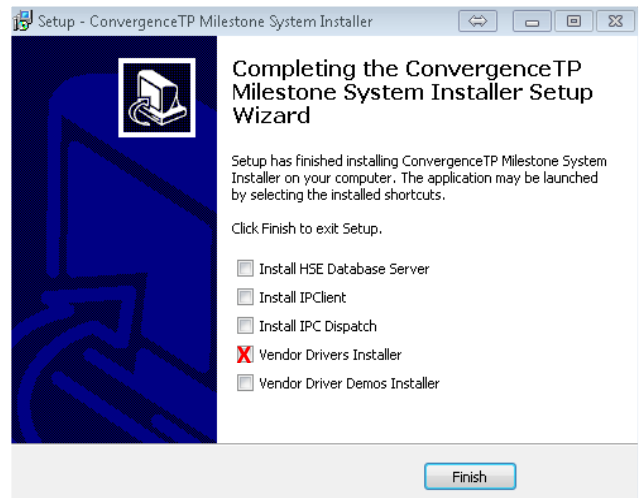

To access the C2P License Server use the Start Menu and select >Programs > ConvergenceTP >

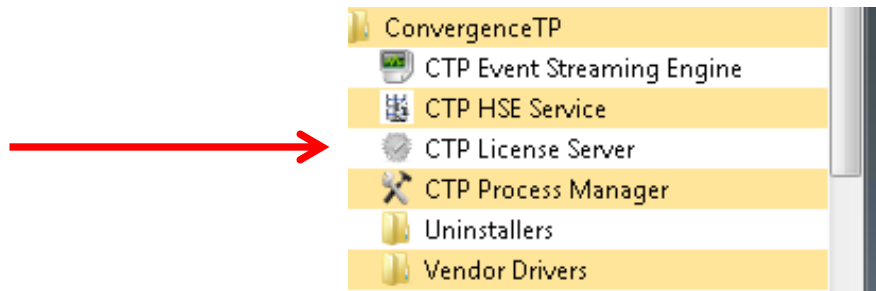

The License Server control panel will come up and you will select Generate Seed Key

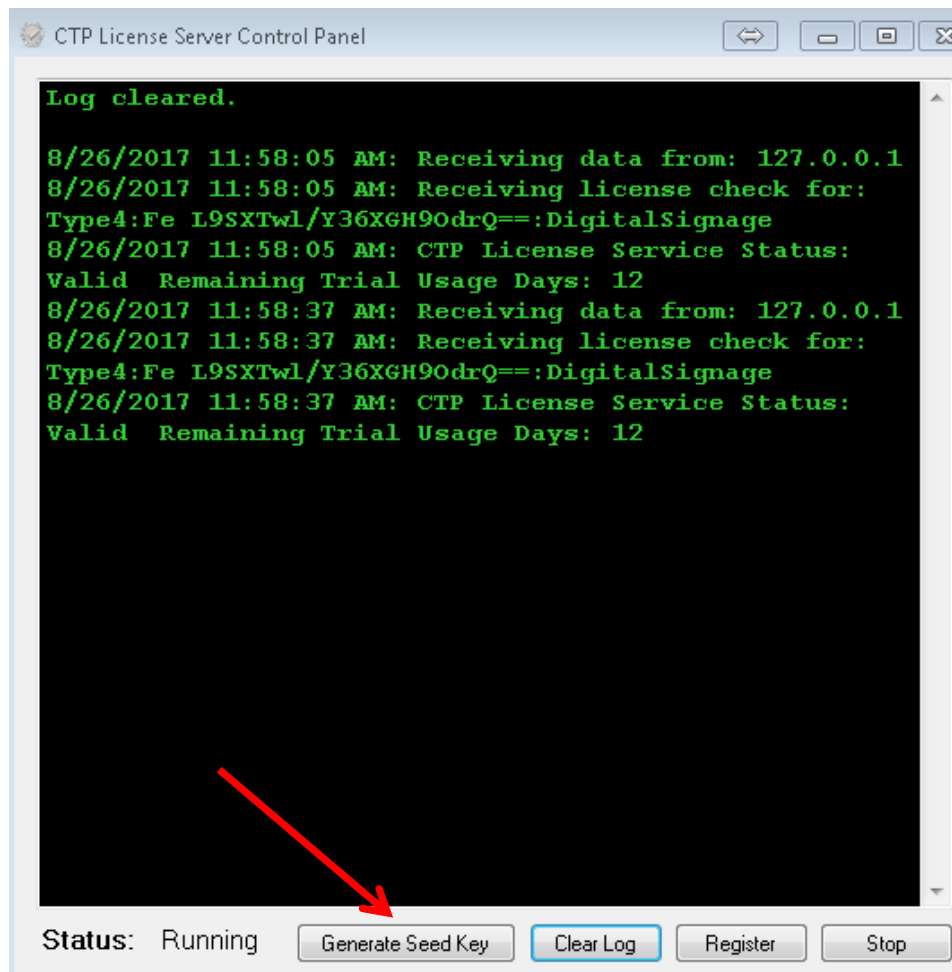

Note2: The “Machine code generator” is only run on the Milestone Base PC/Server. The resultant seed code produced when the Machine code generator is run should then be cut and pasted into an email and sent to Sales@c2p.com.

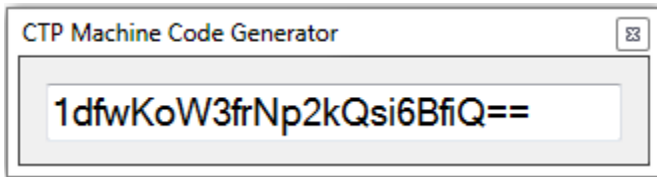

Note: Cut-n-paste the above seed text above into an email. Do not send a screenshot of the text.

Sample C2P Machine code generator output. Email to sales @c2p.com

Installing the C2P ASSET TRACKING Proxy

- 1) To access the C2P Asset Tracking Driver (DHL shown below as an example) use the Start Menu and select >Programs > ConvergenceTP > Vendor Drivers > CTP DHL

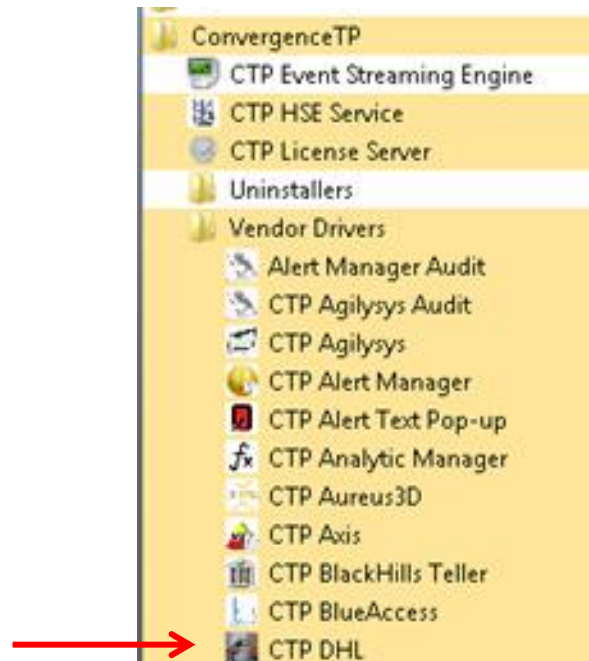

- 2) >Execute the CTP ASSET TRACKING installer. "Run as administrator"

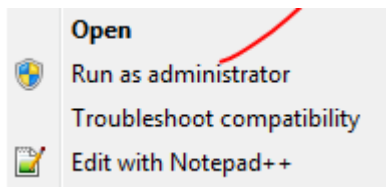

- 3) Follow the default selections

Configuration

If the C2P ASSET TRACKING Installer and the C2P Base are installed on the same PC/Server then no configuration is needed to run the C2P ASSET TRACKING to Milestone VMS integration. This works out nice for setting up demo systems but is not how the system is deployed in practice. Refer to [Figure 1](#) for the expected deployment topology. The Asset Tracking controller needs to be setup as well, see [Appendix D](#) for Asset Tracking setting.

Below is the C2P ASSET TRACKING Installer configuration GUI for demo purposes. (Virtual cameras are all set for Virtual camera #2, not a typical deployment, see sample GUI configuration in [Appendix D](#)).

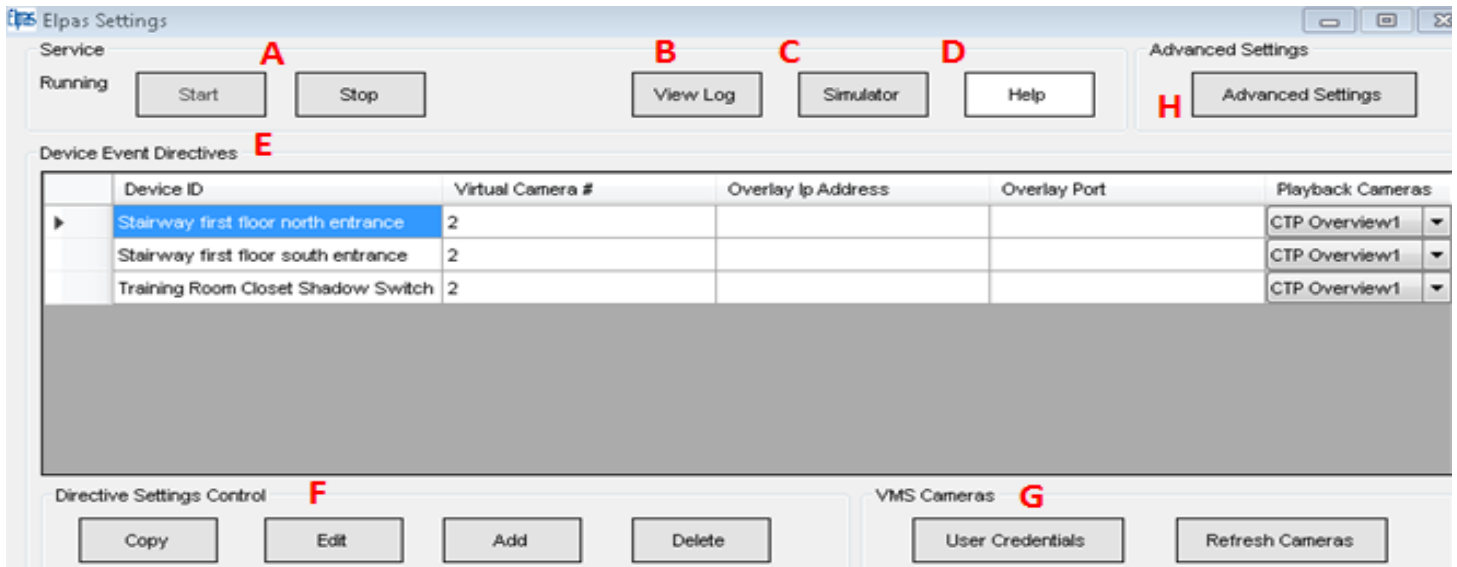

C2P ASSET TRACKING Proxy configuration GUI

A = ASSET TRACKING Service manual Stop and Start controls. When changes are made to the ASSET TRACKING proxy GUI they can manually be loaded into the ASSET TRACKING proxy service by manually stopping and then re-starting the Service or alternatively the user is prompted to have the service restarted automatically when the GUI is closed.

B = View Log. This is an extremely useful real-time **log file** because it tells the user if the ASSET TRACKING Proxy is connected to the ASSET TRACKING application. This log file is the first place to look before testing anything else related to the C2P ASSET TRACKING integration. See also [Appendix A: Sample C2P ASSET TRACKING proxy log files](#)

C = C2P ASSET TRACKING Simulator. The C2P ASSET TRACKING simulator is another very powerful resource for bringing up new installations. The C2P ASSET TRACKING simulator works in parallel with any Asset Tracking data being sent by the ASSET TRACKING system. This allows all of the components of the C2P ASSET TRACKING integration to be completely tested prior to the ASSET TRACKING system running or even installed. Installers can

run the simulator and ensure all of the integration components are functional and then turn on or install the ASSET TRACKING system.

Note: Data from the C2P ASSET TRACKING Simulator DOES get reported in the log file described in item B above.

D = Help button. Explains how to use the F1 key in the GUI to get help text for each item in the GUI.

E = Device Event Directives. This table is used to assign properties to each unique Asset Tracking device name received from THE ASSET TRACKING DEVICE. These properties are used by both the C2P ASSET TRACKING DEVICE proxy and the C2P Hypermedia Search Engine (HSE) during playback of event events.

The “Virtual camera” property defines which generic camera in the recording server will be used to display live exceptions defined in the Rules engine portion of the C2P ASSET TRACKING DEVICE proxy.

The “Overlay address and Port” are optional fields that allow the user to send a copy of the Asset Tracking text received to the overlay data port of external overview camera of the Asset Tracking event.

The “Playback Cameras” are the cameras that will be called up for viewing as a result of the user selecting “Show Cameras” in the Hypermedia Search Engine (HSE). This powerful feature further ties the relevant cameras to the barcode captured event, giving the user overview video of the event at the time of the detection.

F = Directives Setting Control. These are the controls used to add new entries to the Device Event Directives table as well as allow the user to edit existing entries in the table. [See Appendix D for a sample configuration.](#)

G = Milestone Smart Client. The Smart Client controls are used to provide the C2P ASSET TRACKING DEVICE proxy with valid Milestone client login credentials. The C2P ASSET TRACKING proxy uses this login to receive the valid camera names that are assigned to these login credentials. The camera names are then available to the user for use in “Playback Cameras” portion of the Device Event Directives table.

In the expanded view of the VMS Cameras GUI below you can also see that there is a **log file** associated with this function. The log file works extremely well and will give you the detail of why your credentials did or didn’t work. If the credentials entered in the GUI are valid then the log file gives you a list of cameras that those credentials allow you to view.

The VMS Cameras button is shown below.

Note: Url = IP address and port for Milestone Base

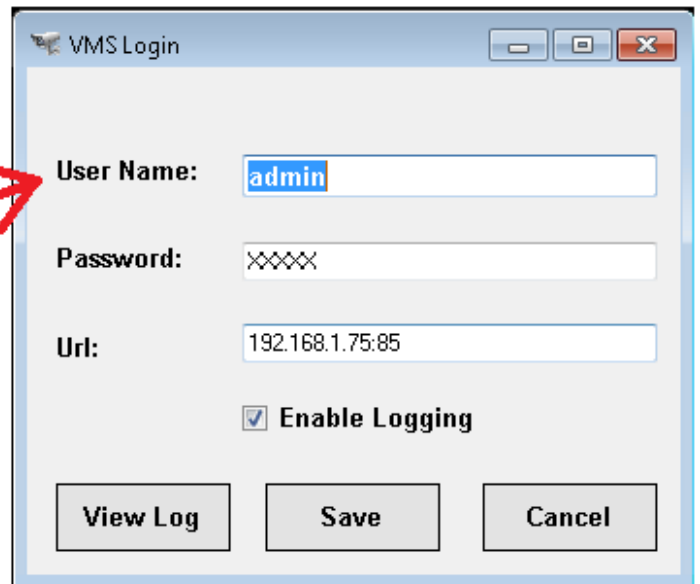
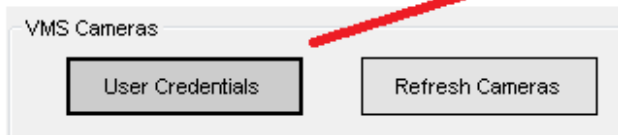

H = Advanced Setting.

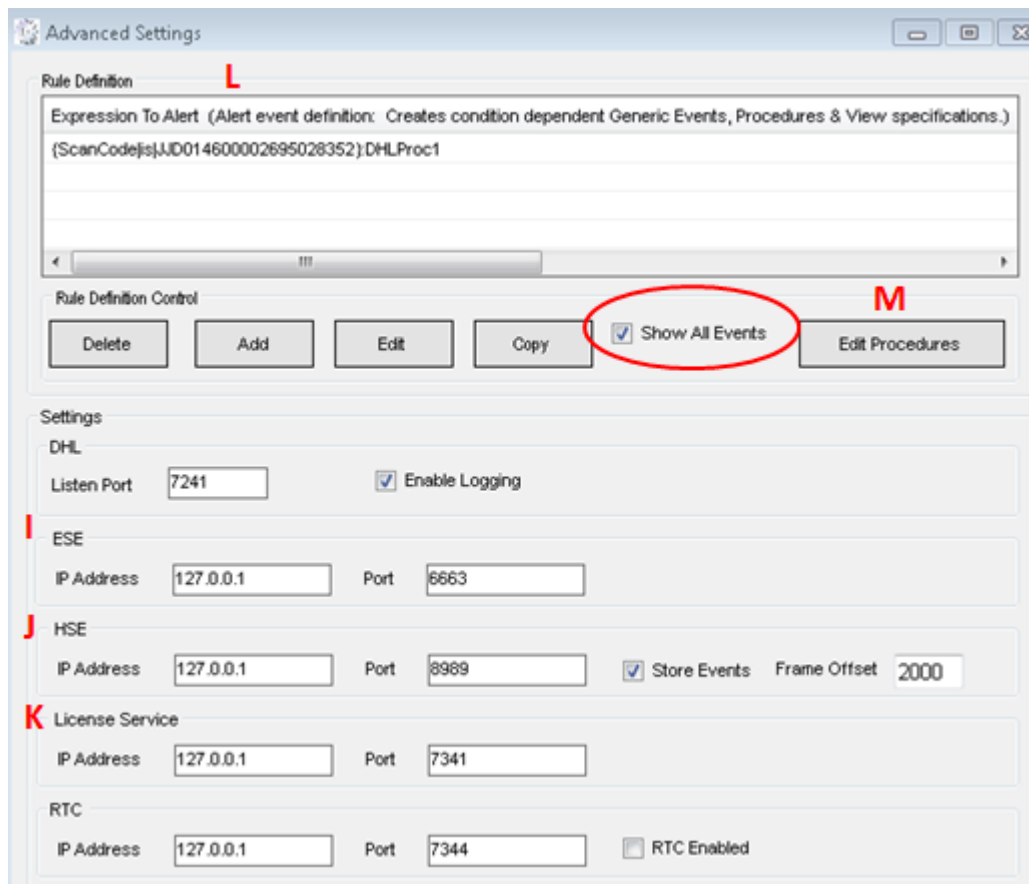

I = Event Streaming Engine (ESE). The ESE is normally installed on a recording server associated the ASSET TRACKING video. See also [Figure 1](#)

J = Hypermedia Search Engine (HSE). The HSE is normally located on the server hosting Milestone Base.

K = License Server. The C2P License Server is normally located on the server hosting Milestone Base.

L = Rule Definition. The Rules Engine is where users can specify unique Asset Tracking data to trigger live events in the Smart Client as well as generate "Generic Events" to Milestone Base. When the "Show All Events" check box directly under the Rules Definition list box is not checked then ONLY the events defined in the Rule Definition list will be shown as live events in the Smart Client. This is done to limit the amount of RFID event traffic sent to the Milestone client to allow the user to see just the critical events happening live. If this is not done the amount of Asset Tracking event data being sent by the C2P/ ASSET TRACKING Virtual cameras can make it nearly impossible to see specific events of interest.

All data received from the system is stored for future viewing in the Hypermedia database so no events are ever lost. The "Show All Events" checkbox has no effect on what is being stored in the Hypermedia database. See also [Appendix B \(C2P ASSET TRACKING GUI Rules Engine\)](#)

M = Edit Procedure. This feature allows the user to create their own text annotation that is displayed as a camera view in the Milestone client in real-time as the Asset Tracking detection event is triggered by the Rules Engine. The procedure can also be setup to generate a Generic Event to the Milestone System if the procedure "Type" is set to "Alert". The Generic Event sent to Milestone will use the "Name" of the procedure as the Generic Event text.

In the example below the Generic Event sent to Milestone when the Pull Cord event occurs will be "ElpasProc1a" as specified in the "Name" field of the Procedure.

Note: Anytime a procedure is edited or created you must select "Yes" when prompted while closing the procedure manager to allow the ESE to be restarted. The ESE reads in the procedures on a re-start.

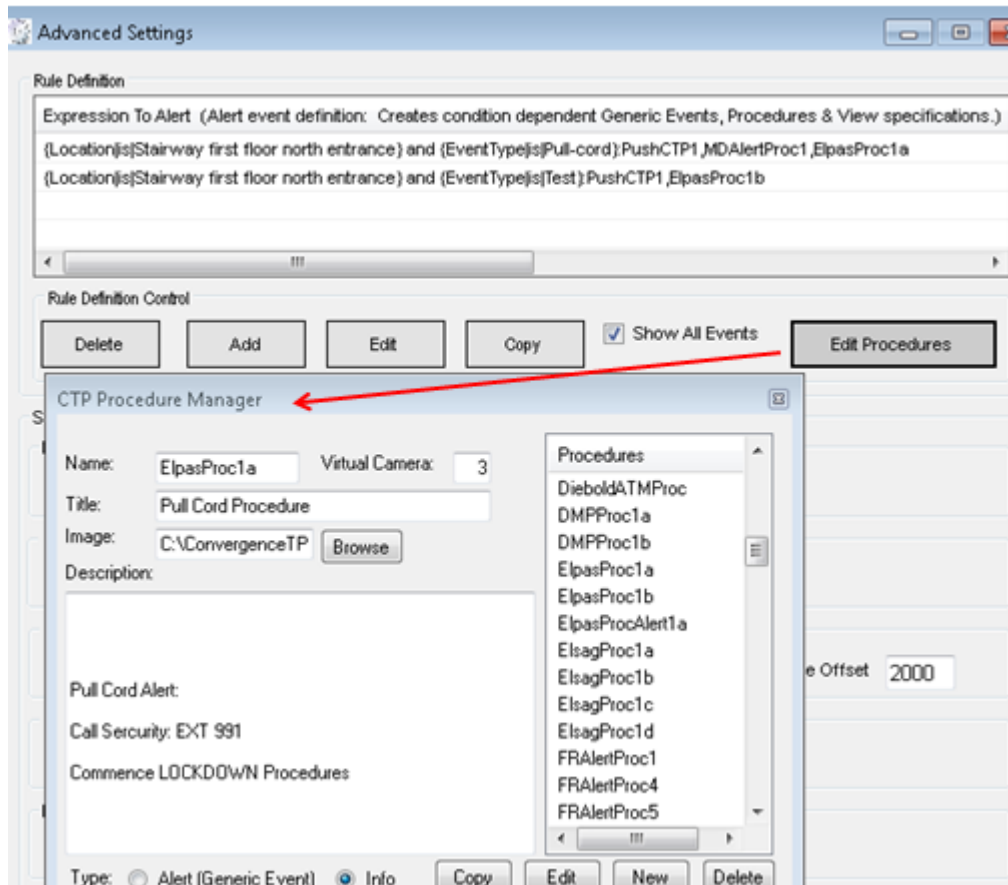

C2P Event Streaming Engine (ESE) GUI

The ESE Control Panel/Log file provides real-time feedback as to what the C2P Proxy is sending the VMS as live Asset Tracking detection point text images to be displayed in the Smart Client. (Including procedures)

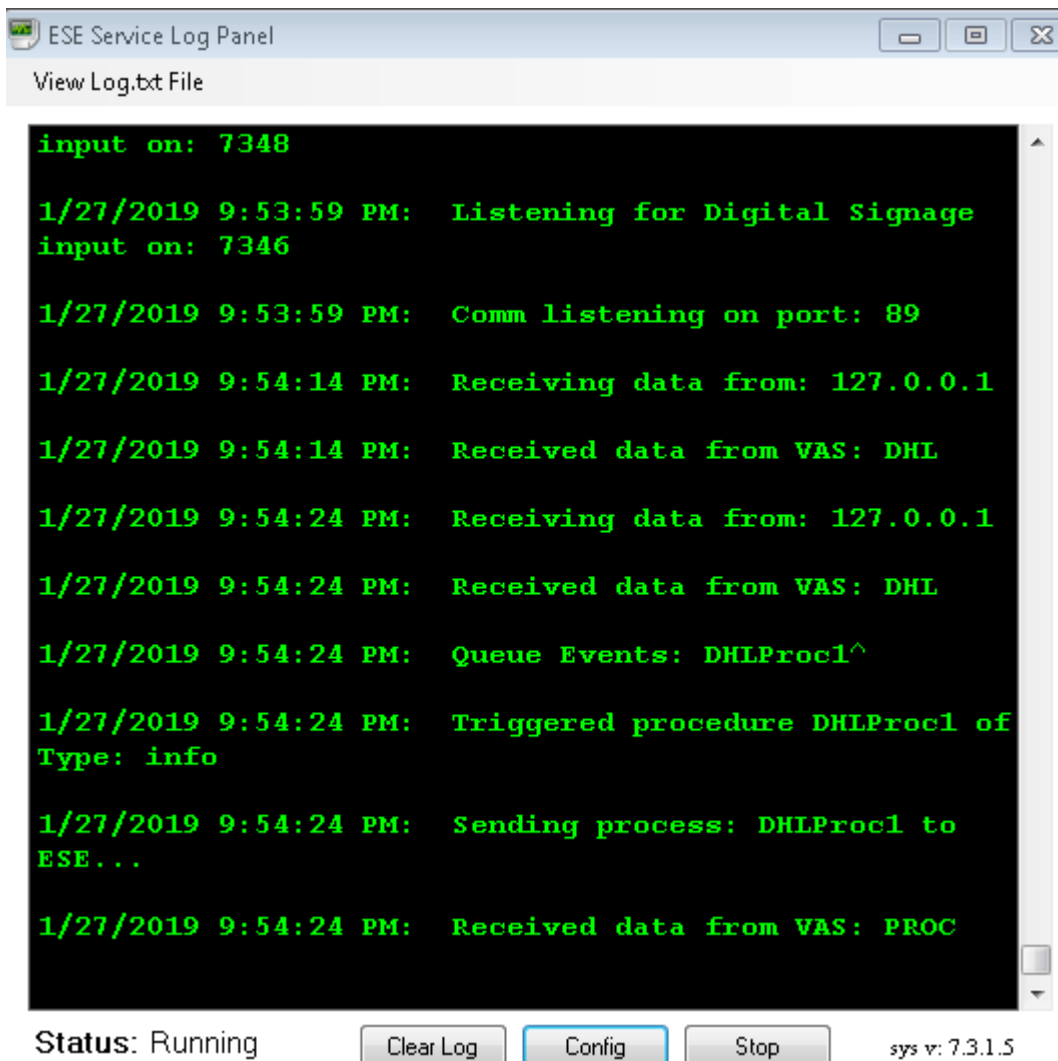

The "Config" button on the bottom of the ESE control panel brings up some configuration settings for the ESE. For non-demo installations the one setting that will likely need to change is the Generic Event IP address.

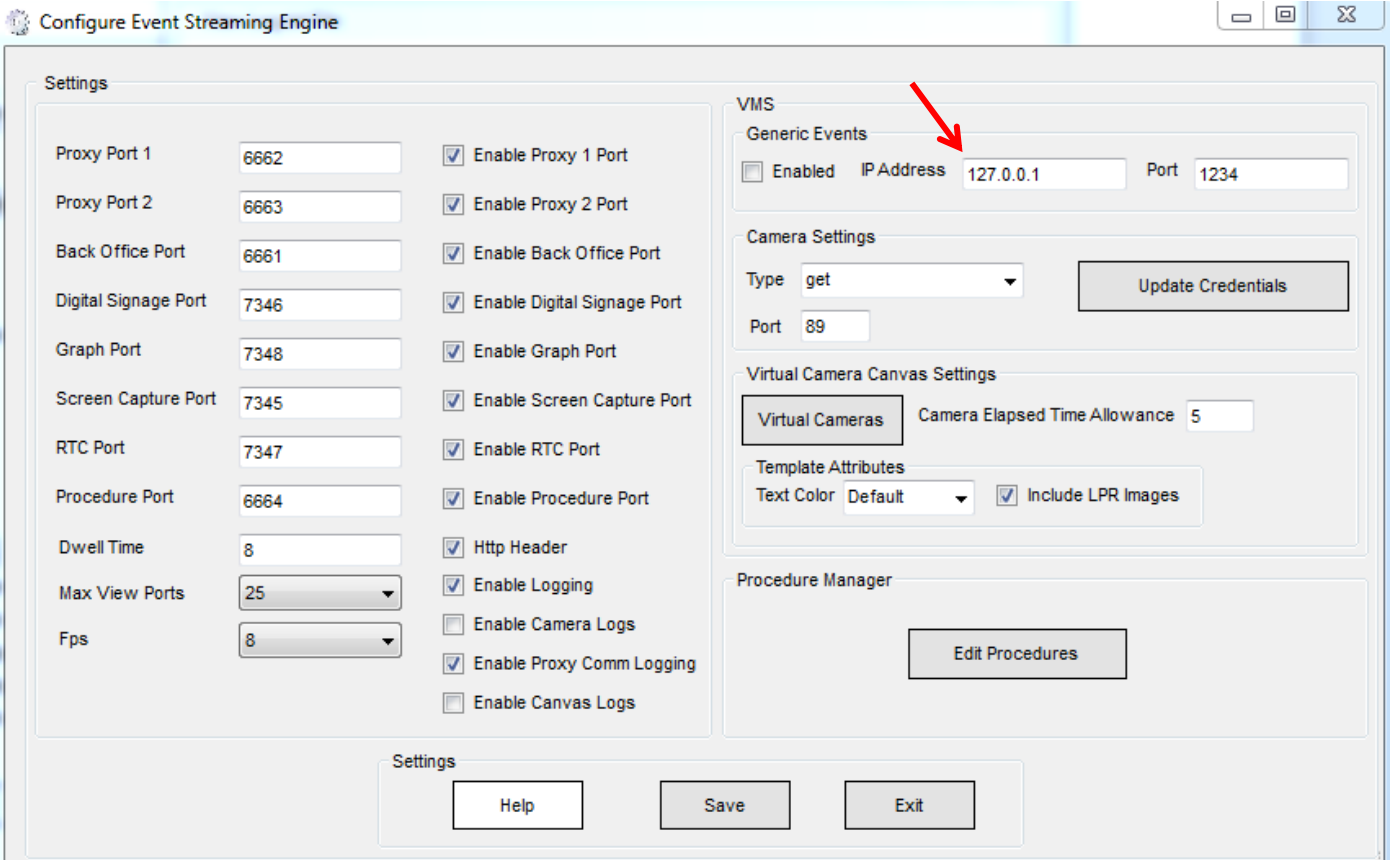

C2P HSE Proxy GUI

The HSE Proxy GUI contains the configuration needed for the C2P ASSET TRACKING Proxy to send Asset Tracking detection point data to the C2P Hypermedia Search Engine (HSE)
In most cases the user never needs to open the HSE Proxy GUI as all of the defaults work as installed as long as the HSE Proxy is installed on the same machine as the HSE = normal case.

Reasons to use this GUI would be

- 1) If the user wanted to change the default Password used by the HSE click on the Update Password button.

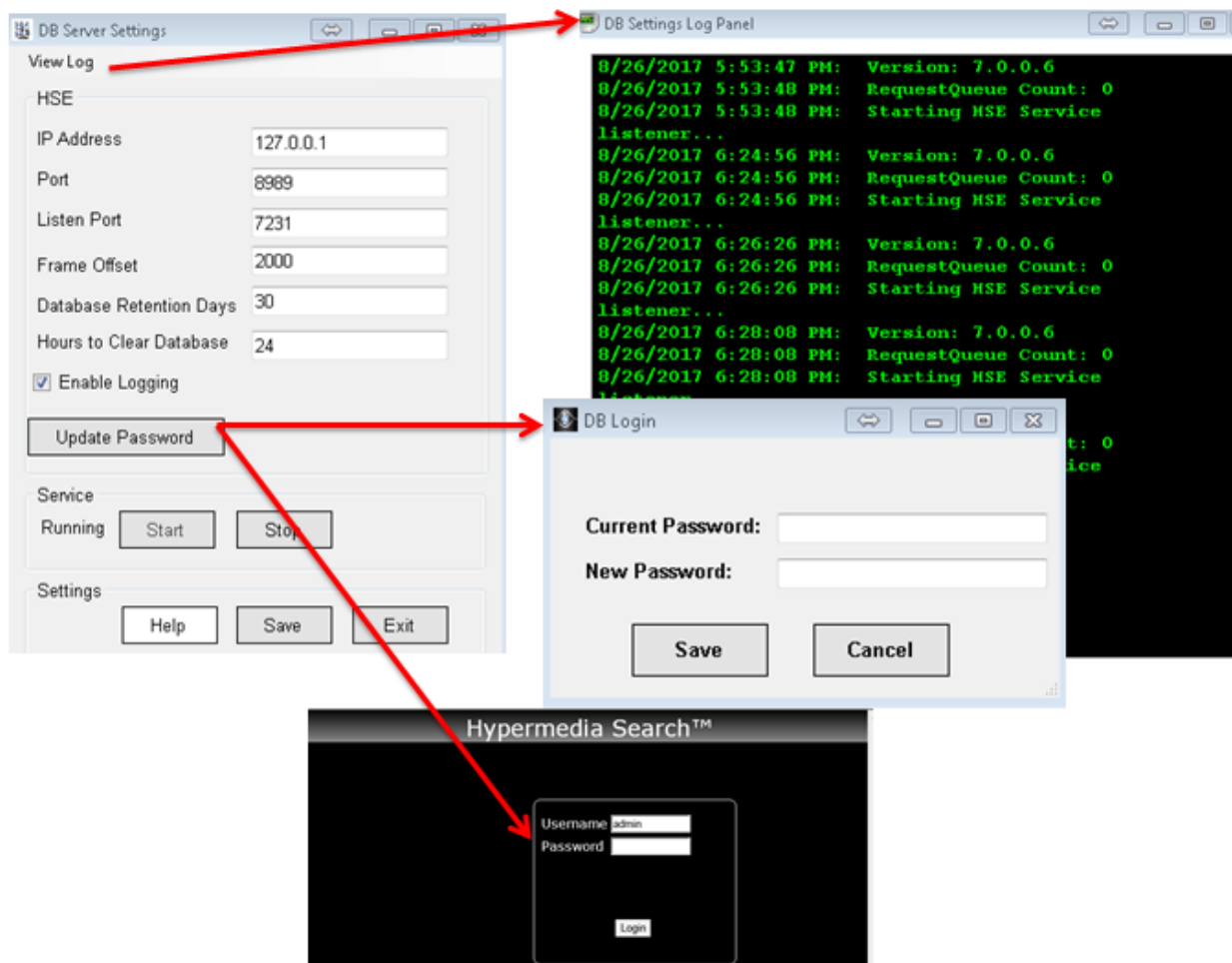

- 2) If the user wanted to change the HSE database retention time from the default 30 days, enter the new time period.

Note: Hours to clear the data base is shown here as 24 hours. Once the 30 day retention has been reached the data base will start to be cleared in 24 hour blocks starting with the first 24 hour storage period. A non-zero number is used to represent how often the database is truncated to the selected number of days specified in "Database Retention Days". If "Hours to Clear Database" is zero (0) then the database is never cleared.

- 3) If the user wants to verify that data is actually being sent to the HSE database. For this they could look at the HSE Proxy View Log file as shown above.

Smart Client view setup for C2P integration

C2P uses a common Smart Client view for all C2P integrations. The view is a 1 + 3 view with the Hypermedia Search Engine (HSE) being in the "1" view and the "3" corresponds to the 3 camera views that are to the immediate right of the HSE view.

Below is an example of a screenshot for the 1 + 3 view setup screen in the Smart Client.

The HSE uses the Web portal for its view.

The URL used = http://IP_Adr:8989 Below this is shown as <http://192.168.1.19:8989>

The cameras are simply drag and drop from the Camera tab.

Note: The default HSE login password is Password1. To change the password see [C2P HSE Proxy GUI](#)

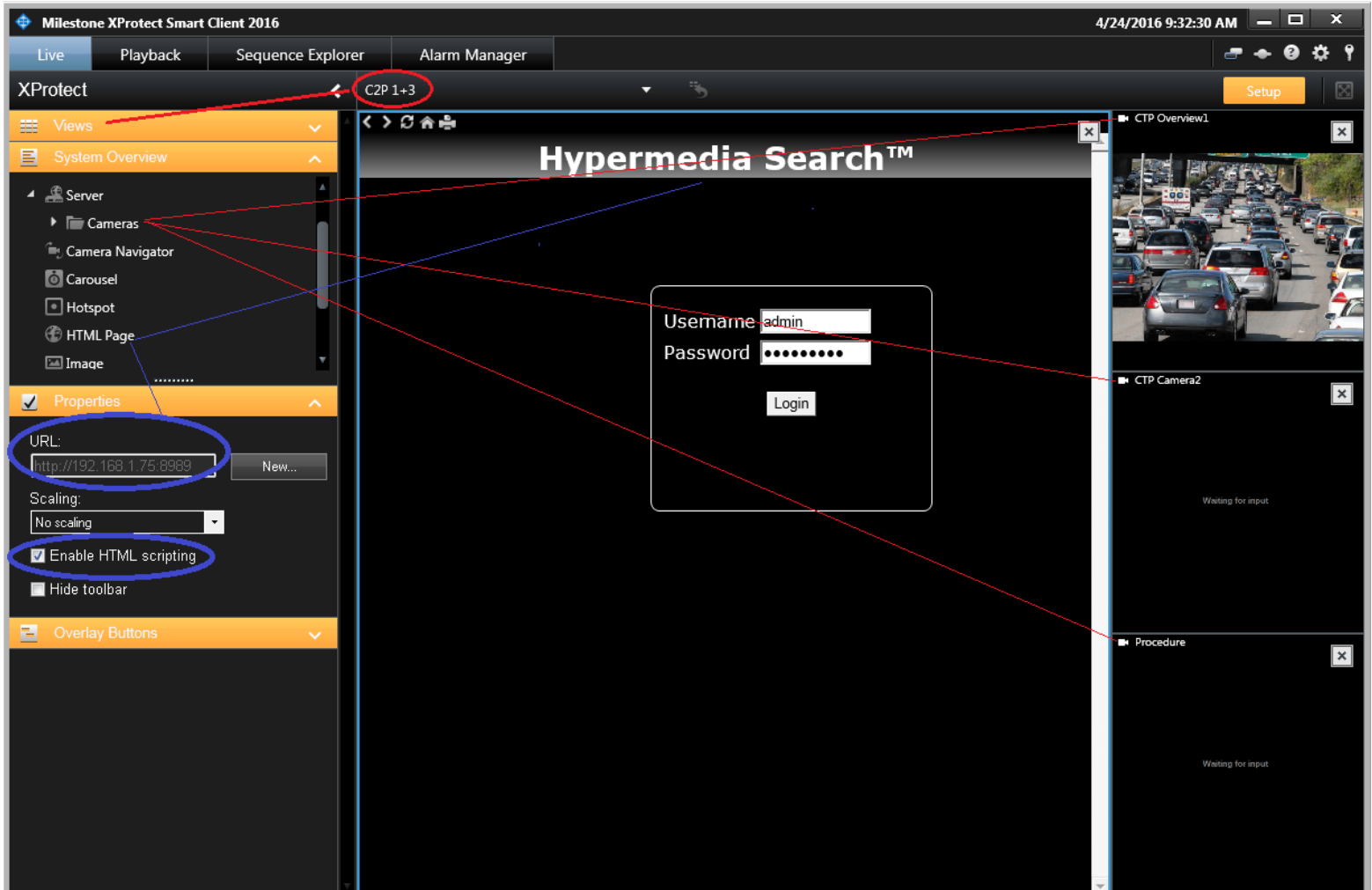

Troubleshooting

In the event that your install doesn't work as planned, or your system stops working at some point, below are some basic troubleshooting tips.

Typical C2P Asset Tracker /Barcode Reader Deployment

Barcode readers

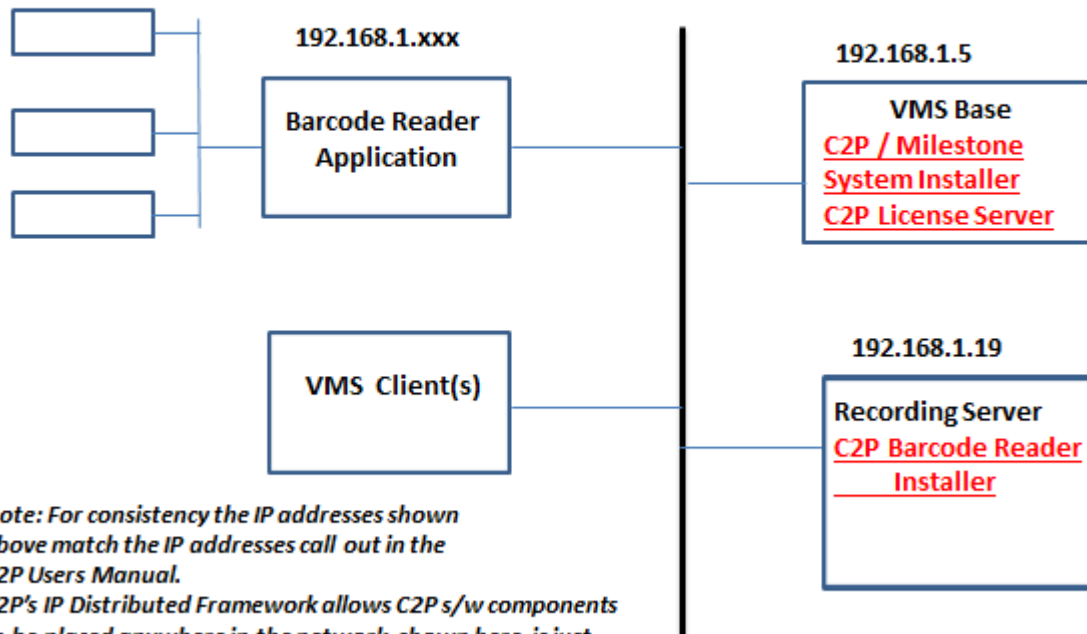

*Note: For consistency the IP addresses shown above match the IP addresses call out in the C2P Users Manual.
C2P's IP Distributed Framework allows C2P s/w components To be placed anywhere in the network, shown here is just One example.
All C2P components need to be time synchronized with each other.*

If you are not seeing metadata events being reported in the VMS client, the first thing you need to do is move to the point in the system where the data first enters the C2P integration.

This is where most people get hung up.

In troubleshooting the rule is:

"The output device is great for alerting you that there is a problem, but that's all it is good for."

As with troubleshooting any electronic device the same basic principles apply = start at the source and work your way through the system to determine where the data goes bad.

Look for things like a blocked port (firewalled) or wrong IP Address specified in one of the C2P settings GUIs.

The block diagram above shows where all of the C2P software components are located with the source located on the machine hosting the ASSET TRACKING Application. This is the starting point, and most likely where the problem resides. The first thing that you want to do is to verify that the C2P ASSET TRACKING Proxy is receiving data from the ASSET TRACKING application. Check the C2P ASSET TRACKING Proxy log file first to verify that the C2P proxy is actually receiving data from the ASSET TRACKING application. The process of checking the log is simple as was illustrated earlier in this User Manual See item "B" in [C2P ASSET TRACKING Proxy configuration GUI](#) and also [Appendix A: Sample C2P ASSET TRACKING proxy log files](#)

Each of the other C2P software components shown in Appendix A all have their own respective Log Files as explained in each of their respective sections of this manual. Use the log files first when troubleshooting. That's what they are there for.

Appendix A: Sample C2P ASSET TRACKING proxy log files

This first screenshot is a log trace of a valid connection between the C2P ASSET TRACKING proxy and the ASSET TRACKING application.

Each ASSET TRACKING proxy has a log file on the front end of the proxy to log every ASSET TRACKING received. If nothing is being received by this log file then nothing is being sent by the ASSET TRACKING application.

The screen below shows what to expect if no connection can be made by the C2P proxy to the ASSET TRACKING application.

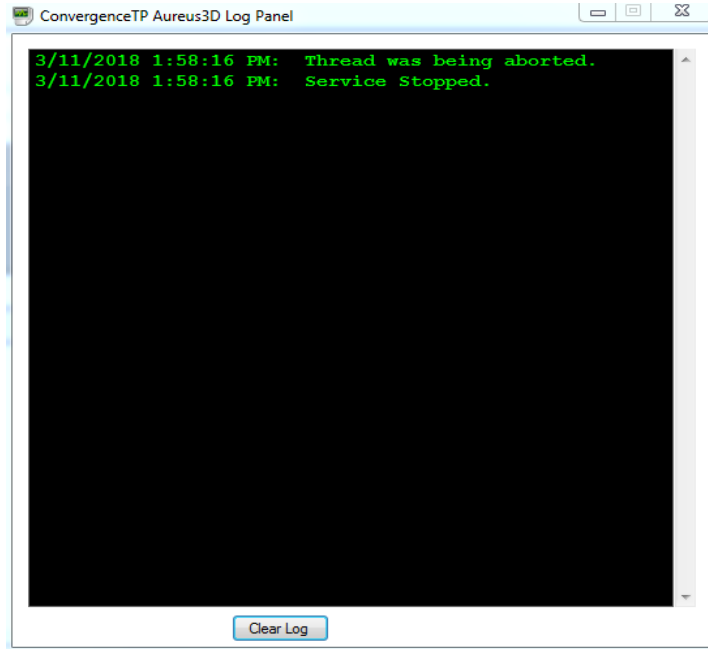

The screen shot below shows active data being received by the C2P Asset Tracking log file.

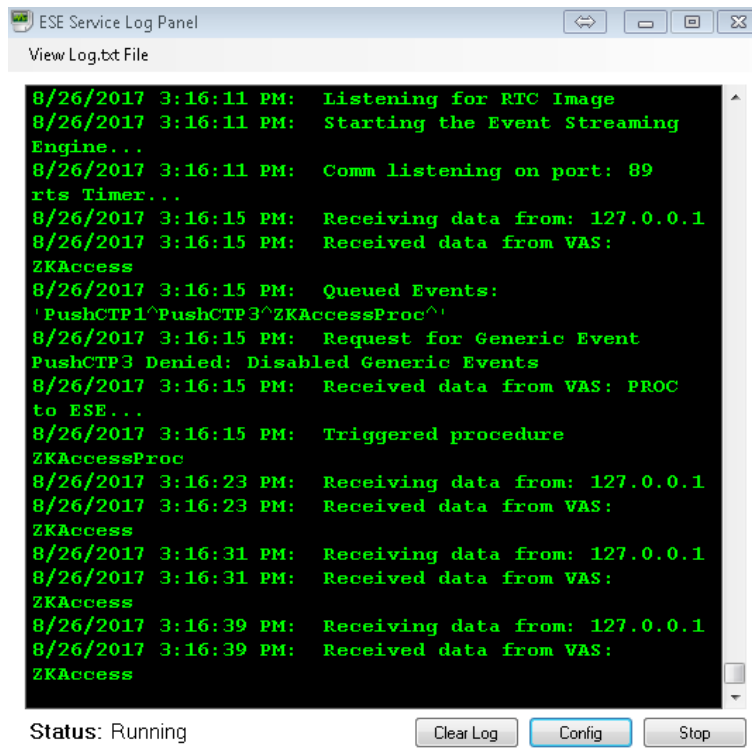

The screen below shows activity in the C2P ESE when data is being received from the C2P Asset Tracking integration.

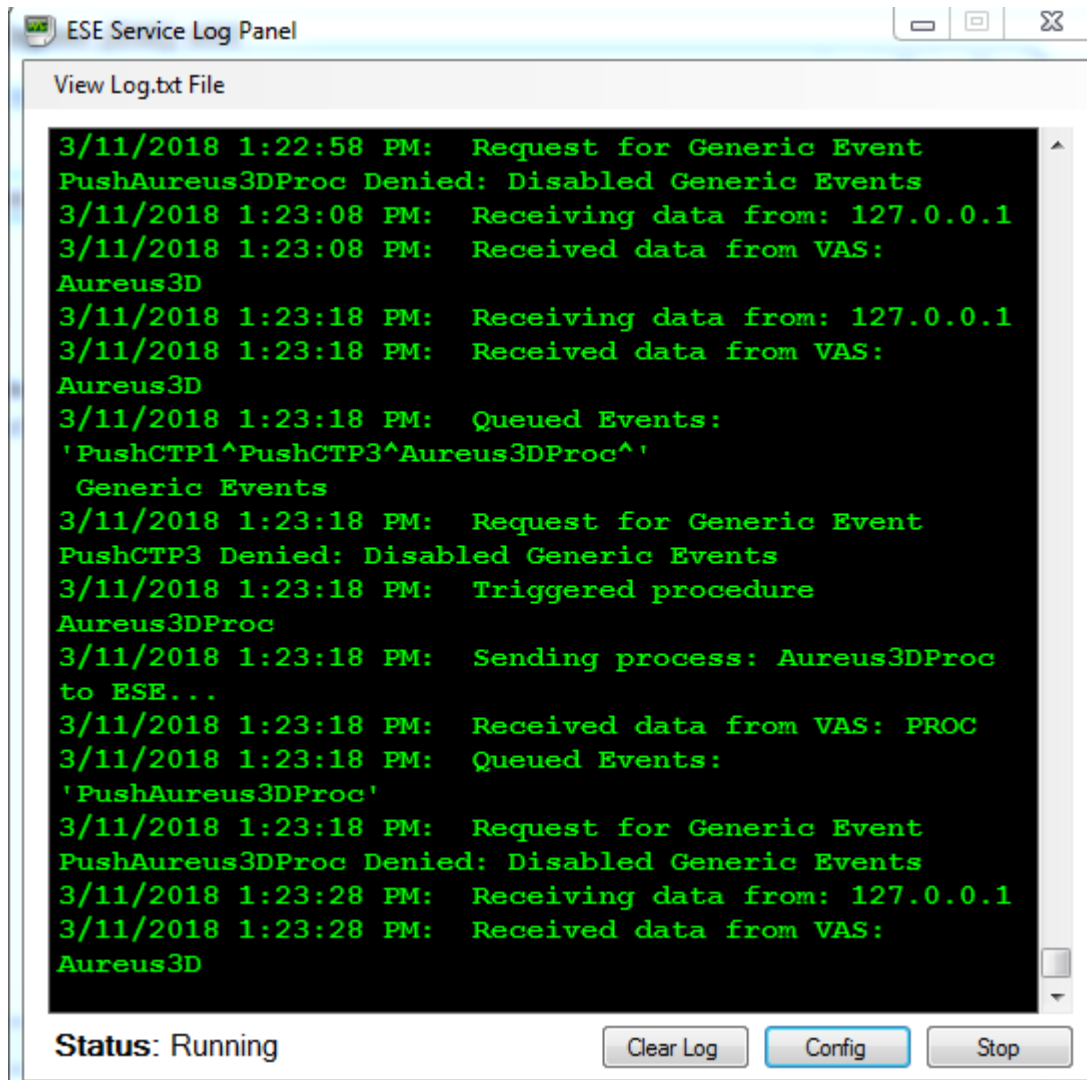

Appendix B: C2P ASSET TRACKING GUI Rules Engine

The C2P Rules engine allows users to create their own rules based on the **Live** text received from the Asset Tracking system.

These rules are evaluated for each ASSET TRACKING detection point read sent from the Asset Tracking system to the C2P integration.

The GUI for the Rules Engine makes it very easy to add, delete or edit a rule. The Rules GUI provides dropdown selections for adding field names. Rules can be a single expression or several expressions AND'd together.

Rules can push a procedure for immediate viewing on the Milestone Smart Client. Rules can be sent Milestone or other 3rd party applications TCP/IP Generic event text.

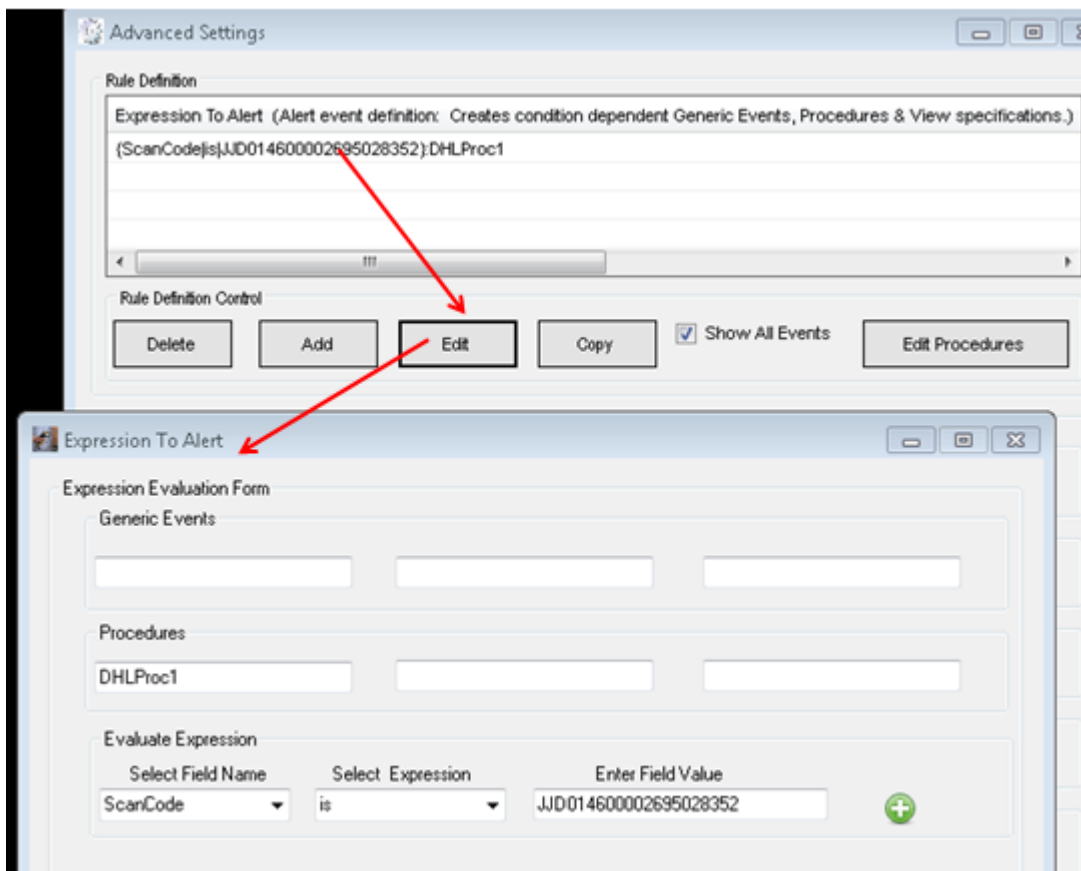

Appendix C: CTP License Server Control Panel

To see the CTP License Server Control Panel you need to be on the machine hosting Milestone Base.
To view the Control Panel you can “Run as administrator” the CTP License Server desktop icon. See below.

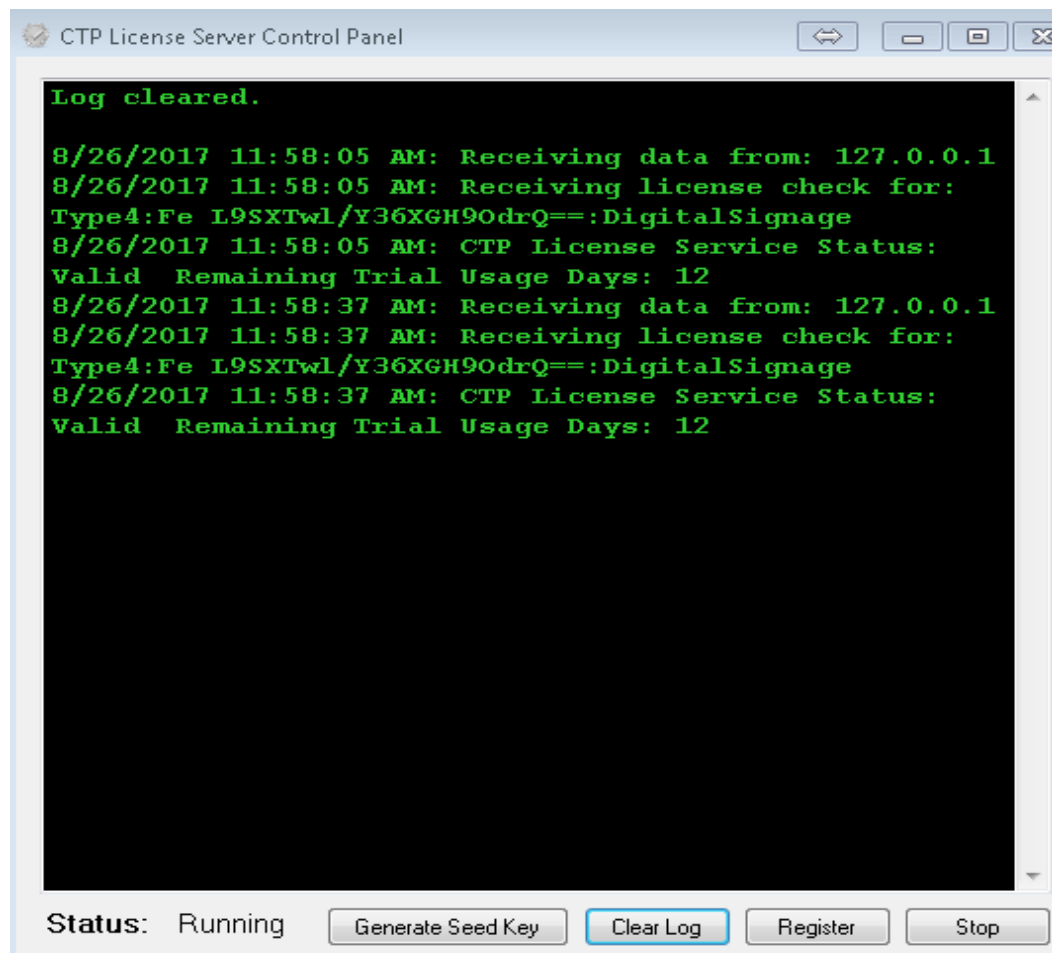
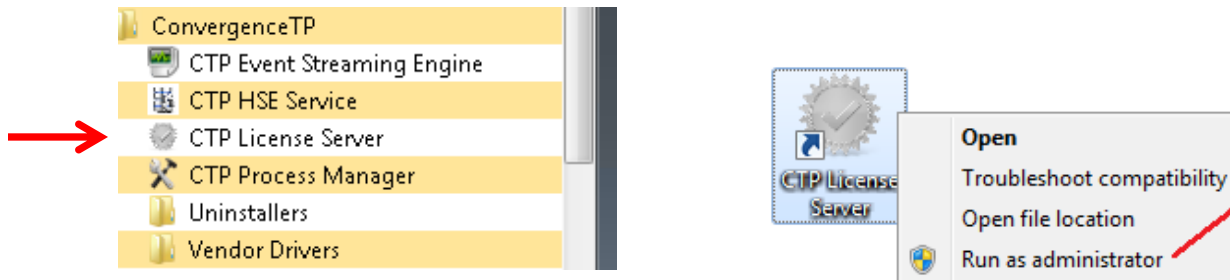

If the CTP License Server icon is not on the desktop you can also run the executable in:

C:\ConvergenceTP\License server  CTP License Control Panel.exe

The License Server Control Panel is where real-time licensing information is displayed.

The License Server is also where the Generation of a Seed Key is initiated so a permanent C2P license can be generated and returned to be installed using the Registration button.

The License Server is also used to install the registered license, by clicking on the Register button and following the instructions.

Loading a new CTP License File

You can also load in your purchased license files using the “Register” button on the bottom of the panel. If you do Register a new license using the Control Panel BE SURE TO STOP AND START THE CONTROL PANEL afterwards.

Note: The new license is not read in until the License Server service is restarted so it’s important to stop then start the service using the “Stop” button below, which turns into a “Start” button once the service has stopped.

Also shown below is what the Control Panel looks like when a demo license expires and then a valid license is loaded using the Register button process. The valid license was loaded in at 4:30:18 PM.

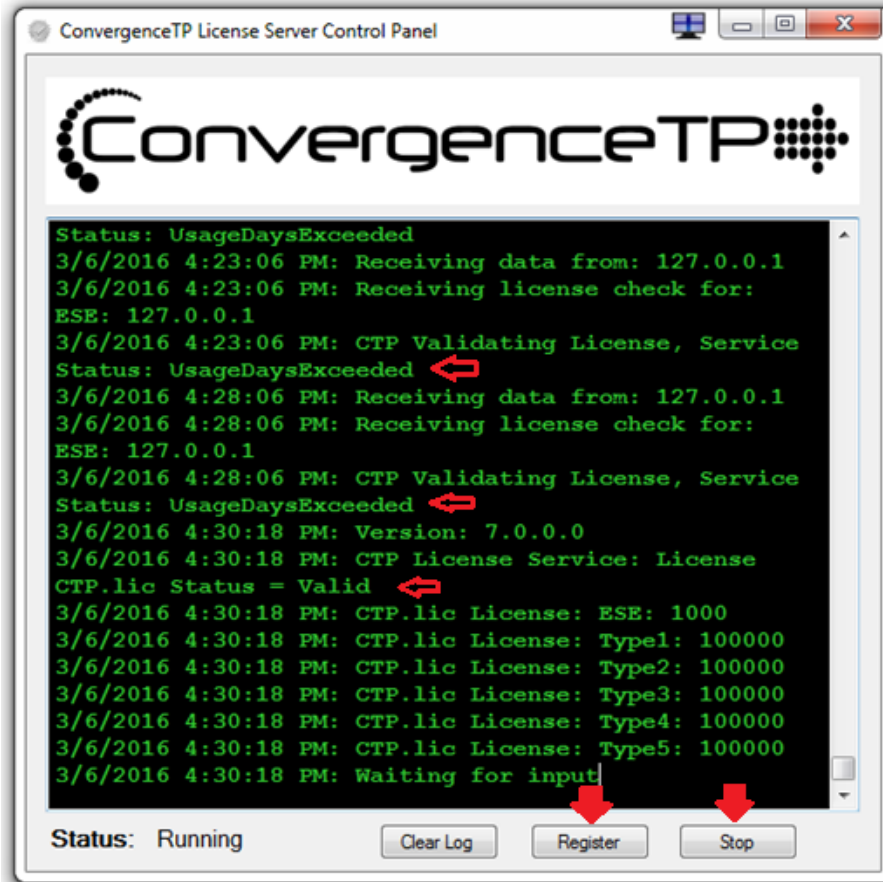

Appendix D: C2P Asset Tracking Settings Configuration Panel

The diagram below shows the association between the C2P Asset Tracking GUI and the C2P HSE search Engine embedded in the Smart Client. The GUI is used to establish which Device ID's data will be placed in the client viewport when Show Cameras button on the client is selected in the search engine. The GUI allows the selection of cameras to be viewed using the drop down menu*. When Show Cameras button is selected the assigned camera views (CTP Overview1, CTP Camera2 and Procedure) will be brought up and will be time synchronized with the device ID data and placed in the client as viewports 1, 2 and 3, respectively. In the case shown below the CTP Camera2 Asset Tracking data will appear in viewport2 along with time synchronized video from CTP Overview1 in viewport1. Viewport3 is also time synchronized and is showing a Procedure (Virtual camera named Procedure) for security personnel to be aware of when that event is detected.

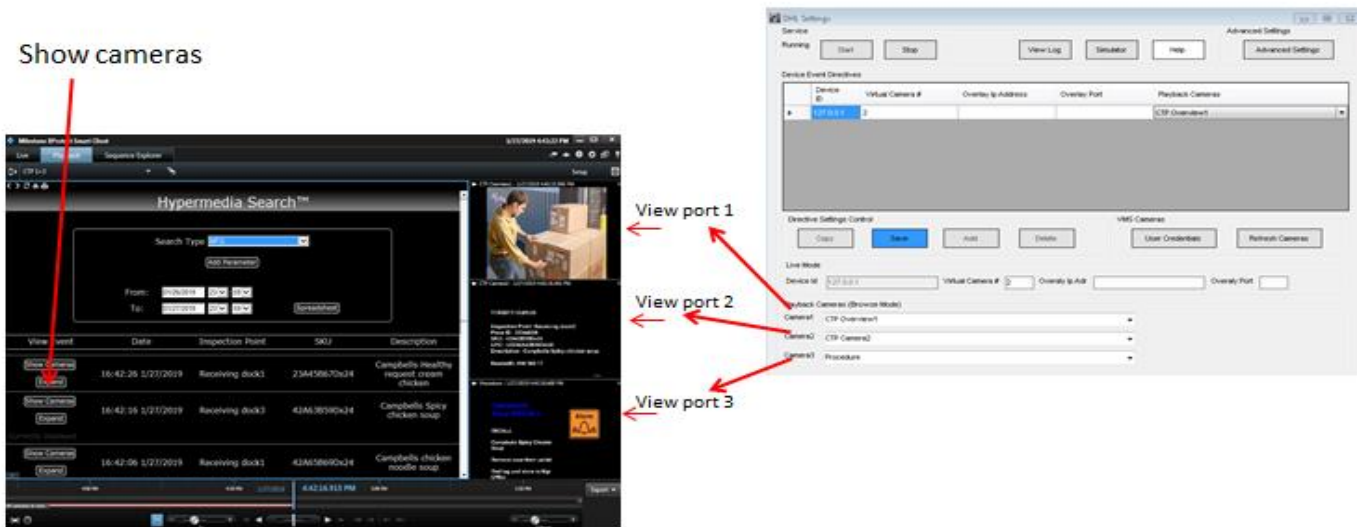

* Note: when using the drop down camera view list, only cameras Views you have privileges to view will be listed.

If only one camera view is selected in addition to the Asset Tracking data it is recommended to have a separate camera view placed in viewport3. If you are not using a Procedure as shown above you may use any other camera but do not use "blank screen" camera here.

Appendix E: Milestone Enterprise, Professional and Express setup

This section outlines how to setup Virtual Cameras using the Milestone Universal Cameras for either 16 or 64 channel cameras.

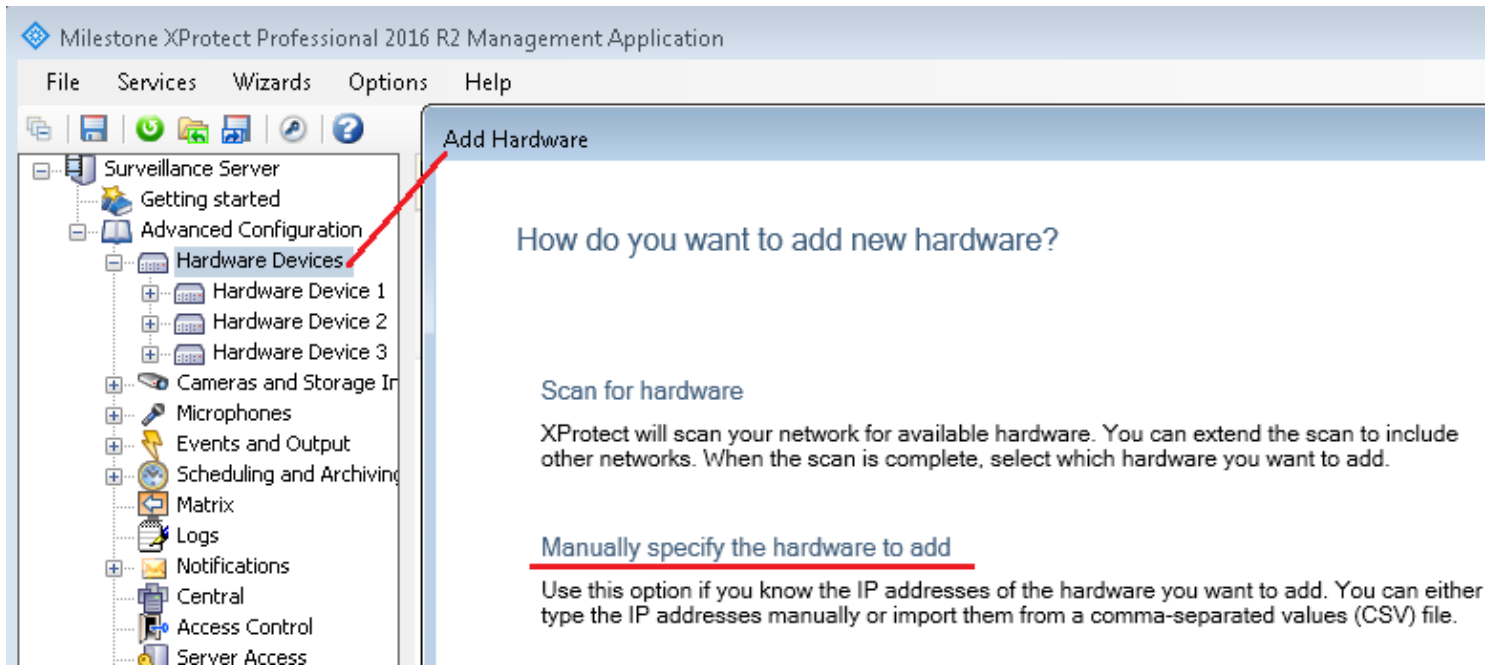

Next select "Manual" mode for the hardware detection method.

Select "Universal" as the camera type

In the Add Hardware form:

The Address is the address of the PC/Server hosting the C2P ESE

The Port is 89

The Hardware model is Universal "xx" channels where xx can be 1, 16 or 64

Add Hardware

Type IP addresses

Type the IP addresses of the hardware you want to add to your system or import the information from a comma separated values (CSV) file. You can speed up the scanning process by selecting the manufacturer(s) of the devices you want to add.

| IP Address | Port | User Name | Password | Driver |
|--------------|------|-----------|----------|---------------------------|
| 192.168.1.19 | 89 | <default> | | Universal 16 channels d ▼ |
| IP Address | 80 | <default> | | Auto-detect ▼ |

Next enable the Universal channels needed being sure to **DISABLE ALL MICROPHONE CHANNELS**

This completes adding the Universal Camera definitions.

Next you will need to name the individual camera names and configure each individual camera and setup each virtual camera.

Hint: *Use camera names that are easy to associate with your access points.*

Milestone XProtect Professional 2016 R2 Management Application

File Services Wizards Options Help

Surveillance Server

- Getting started
- Advanced Configuration
 - Hardware Devices
 - Hardware Device
 - Hardware Device
 - Hardware Device
 - Hardware Device
 - Camera 1
 - Camera 18
 - Camera 19
 - Camera 33
 - Camera 34
 - Camera 35
 - Camera 36

Camera Settings Summary:

| Enabled | Camera Name | Properties | Video Format | Record on | Retention Time | Recording Path |
|-------------------------------------|-------------|------------|--------------|------------------|----------------|--------------------------|
| <input checked="" type="checkbox"/> | Camera 1 | Open | Querying... | Motion Detection | 7 | Day(s) X:\MediaDatabase\ |

Select camera properties and follow settings outlined below.

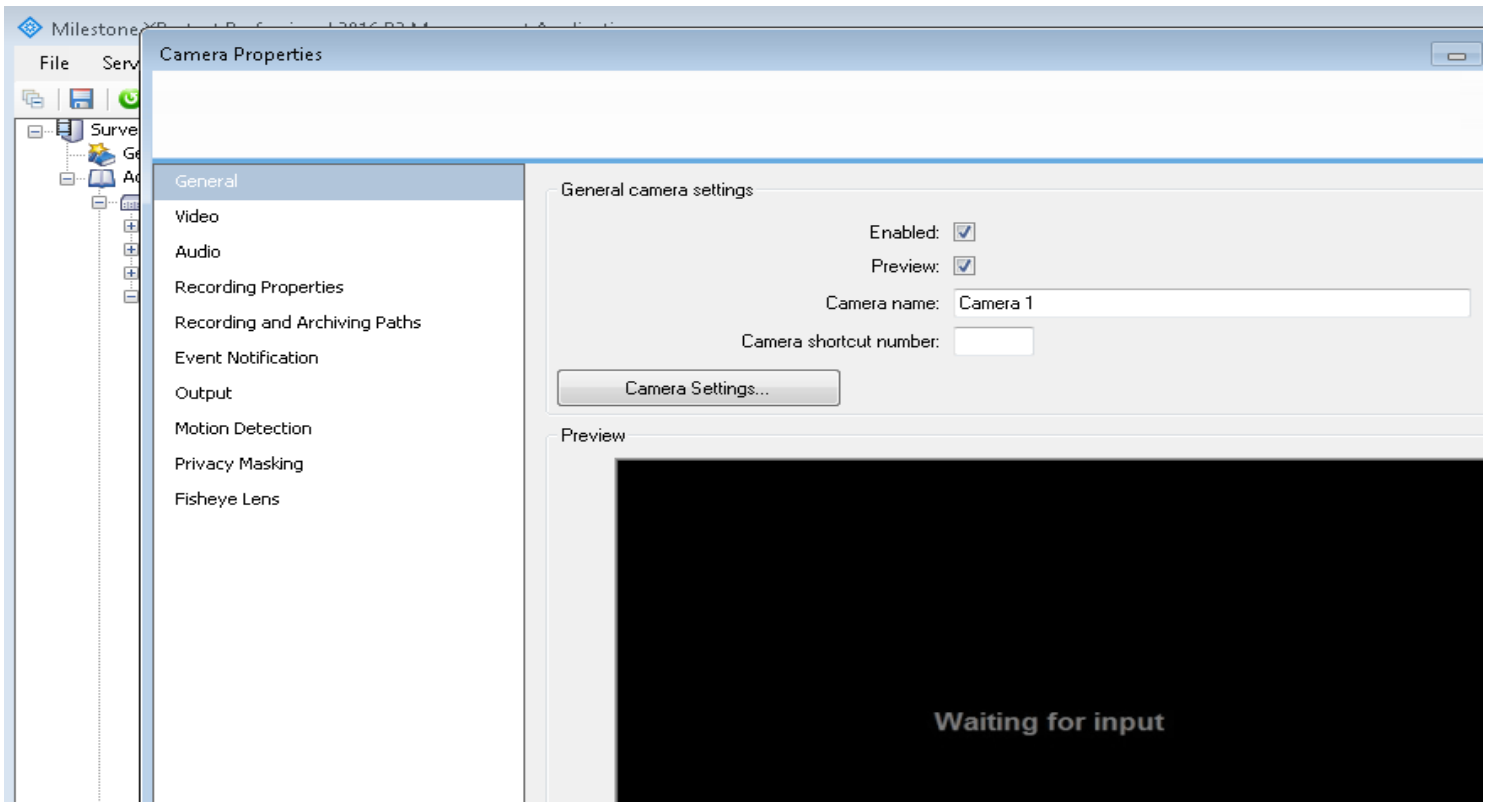

Configure Camera properties as shown below. Assign the `getportX` URL connection for each Asset Tracking detection point where `X` is the virtual camera differentiator. If you have 20 Asset Tracking detection points you will have `getport1` thru `getport20` virtual cameras.

As an example a table would help in keeping track of the Asset Tracking to device ID and virtual camera assignment.

| Asset Tracking name | Device ID | Virtual camera # | Virtual camera name (optional) | comment |
|----------------------------|------------------|-------------------------|---------------------------------------|----------------|
| Main Lobby | 1 | 1 | Camera1 | getport1 |
| Storage | 2 | 2 | Camera2 | getport2 |
| Loading Dock | 3 | 3 | VC3 | getport3 |
| | | | | |
| | | | | |
| | | | | |
| | | | | |

Camera Properties

General

Video

Audio

Recording Properties

Recording and Archiving Paths

Event Notification

Output

Motion Detection

Privacy Masking

Fisheye Lens

General camera settings

Enabled:

Preview:

Camera name:

Camera shortcut number:

[Camera Settings...](#)

Preview

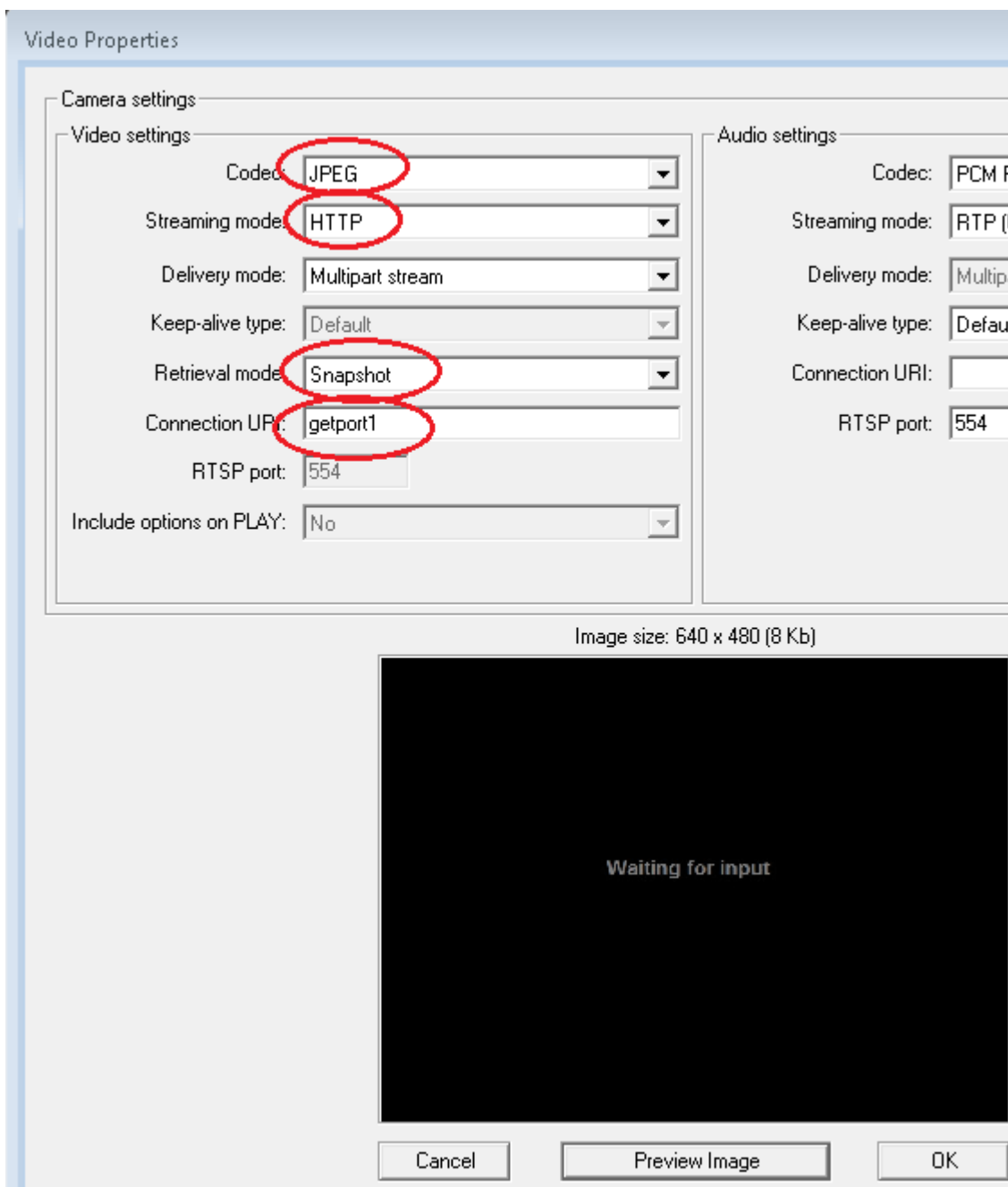

Note : Retrieval mode used here is Snapshot, this is different when using Milestone Plus Series mode.

Appendix F: Universal Camera Setup using Plus Series Platform

Login defaults to Windows authentication.
You can add a "Basic" account if needed

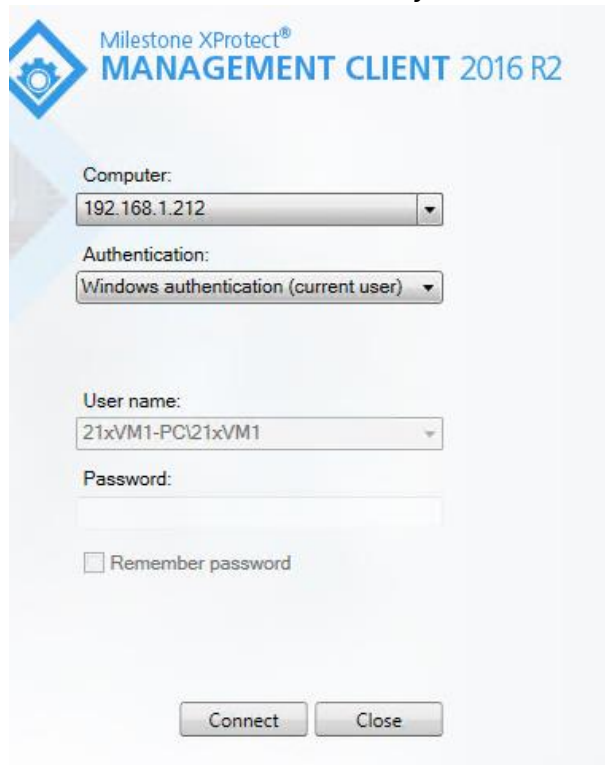

Add new hardware

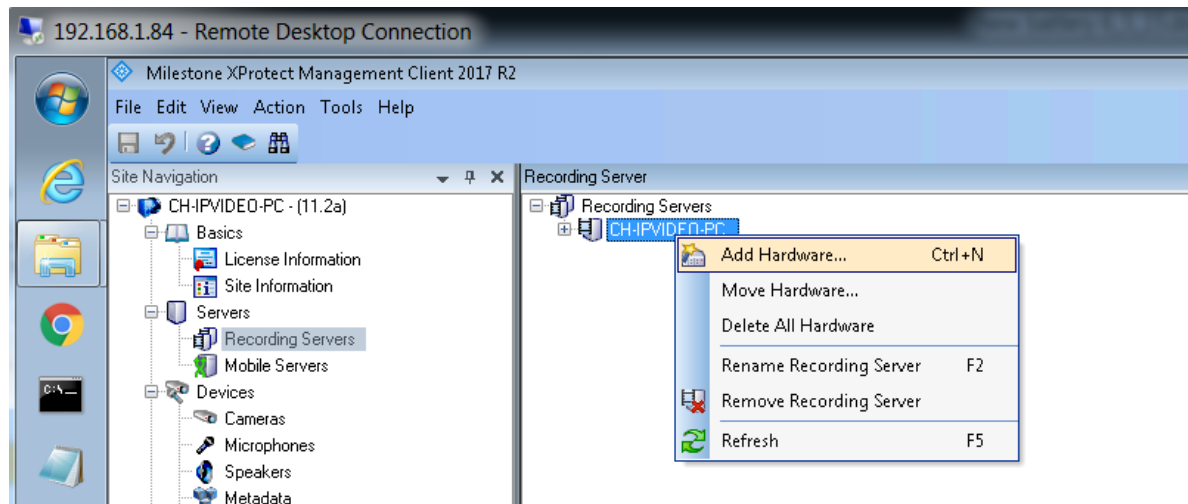

Note Milestone Corporate and Expert may require this step below

When you go to your recording server for the first time you need to right click on it to “Authorize” it, then you can add hardware devices.

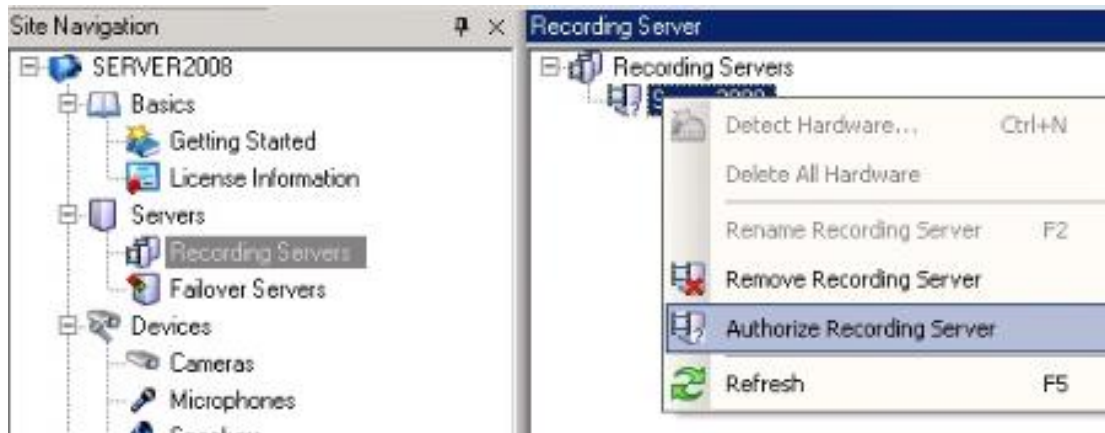

When prompted deselect the Universal cameras not used.

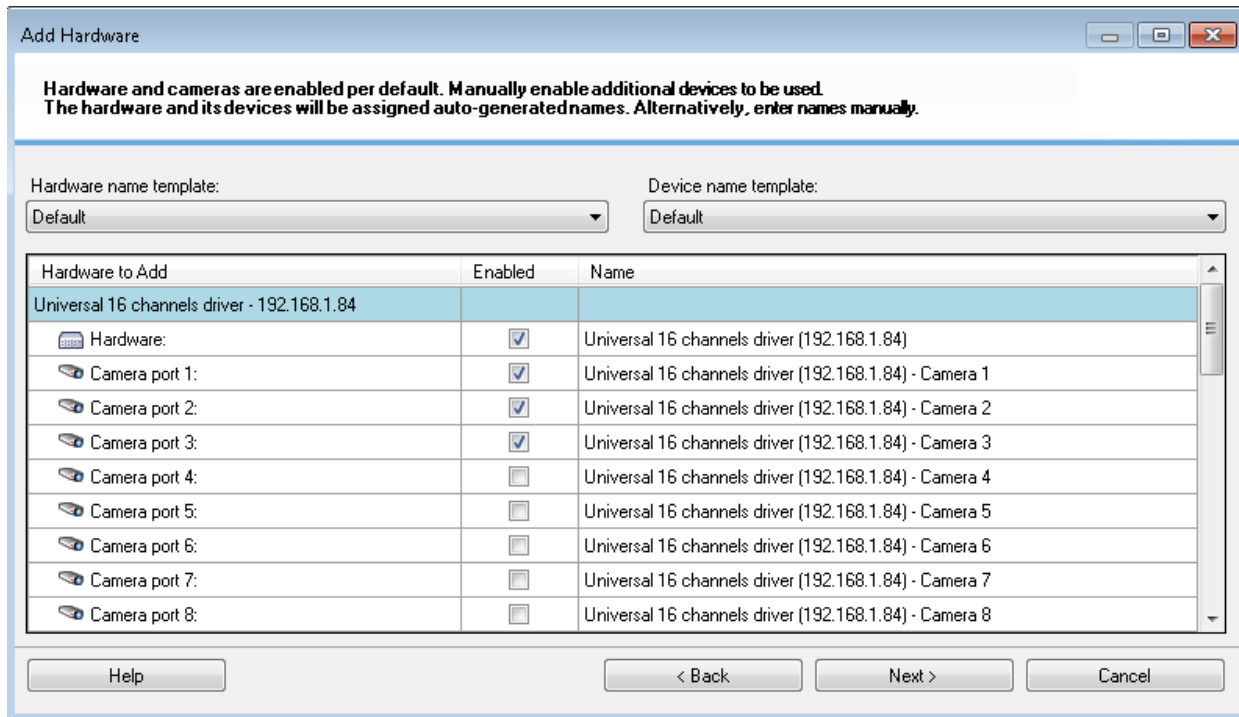

Next create a C2P group

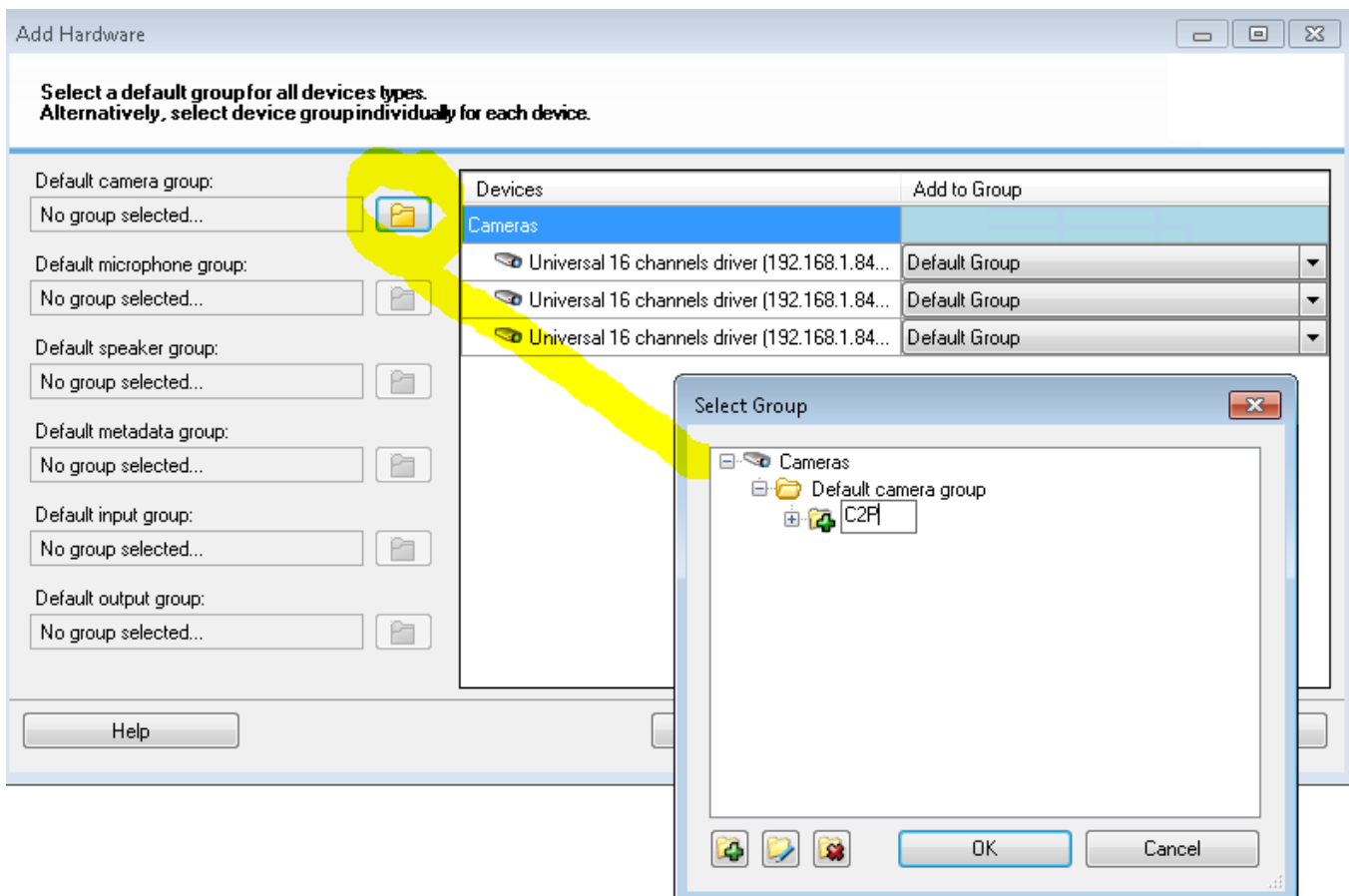

Next build the individual C2P cameras

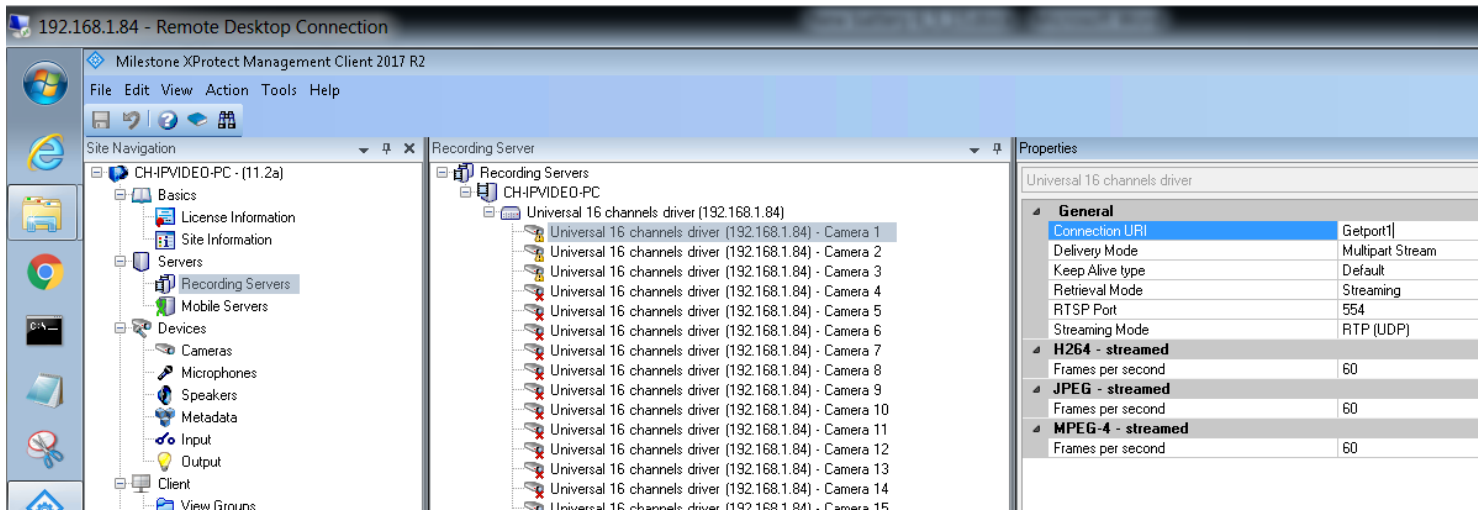

Name the camera using the "Info" tab at the bottom of the screen

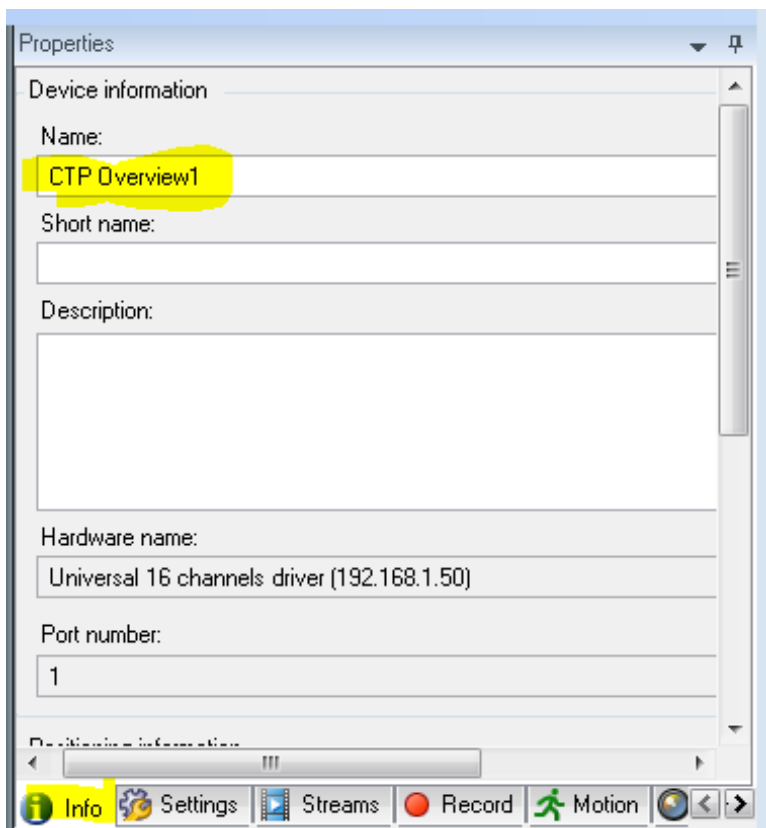

Note that Milestone "Plus" systems requires "streaming mode" below for the universal cameras.

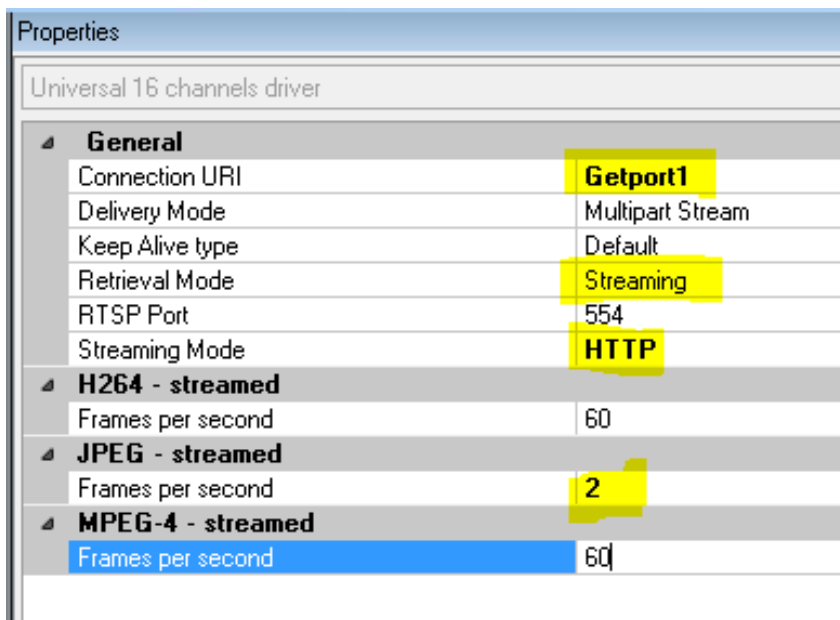

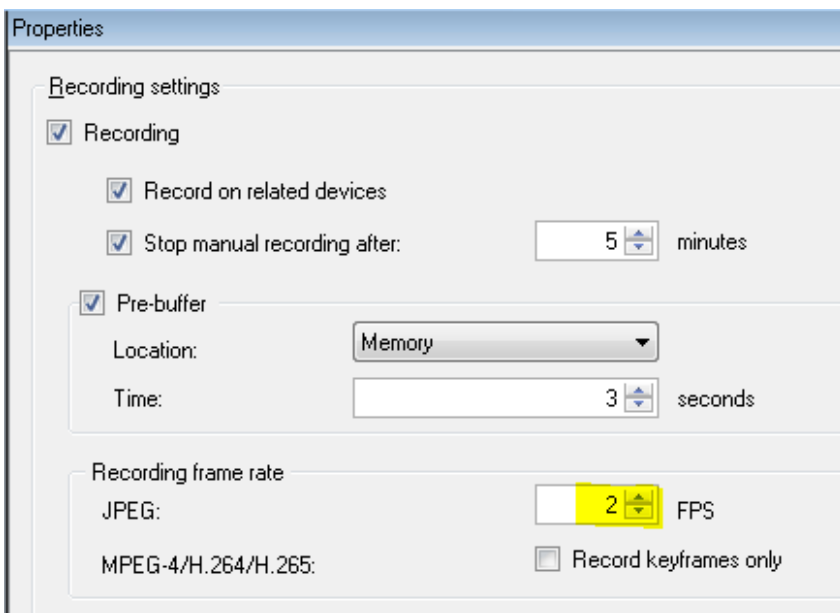

Add a Rule to set C2P cameras to record always

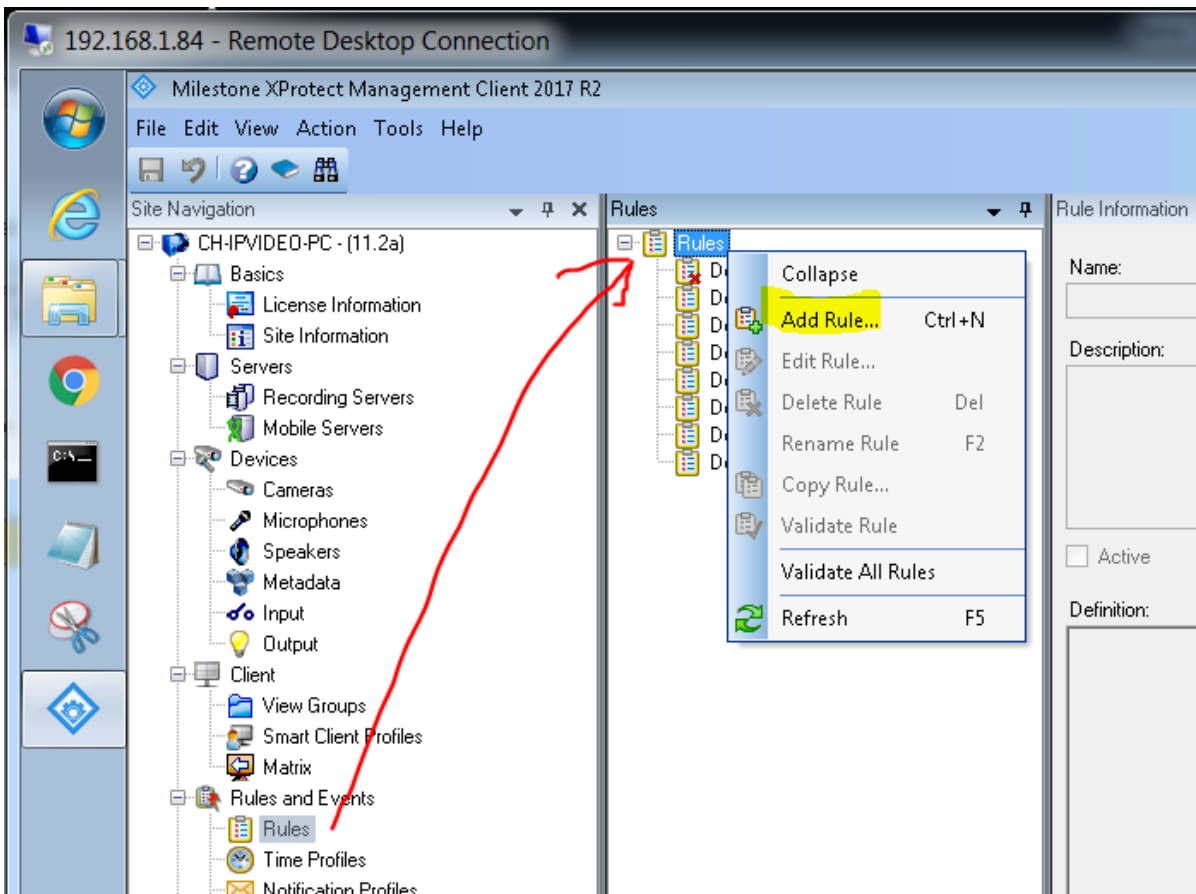

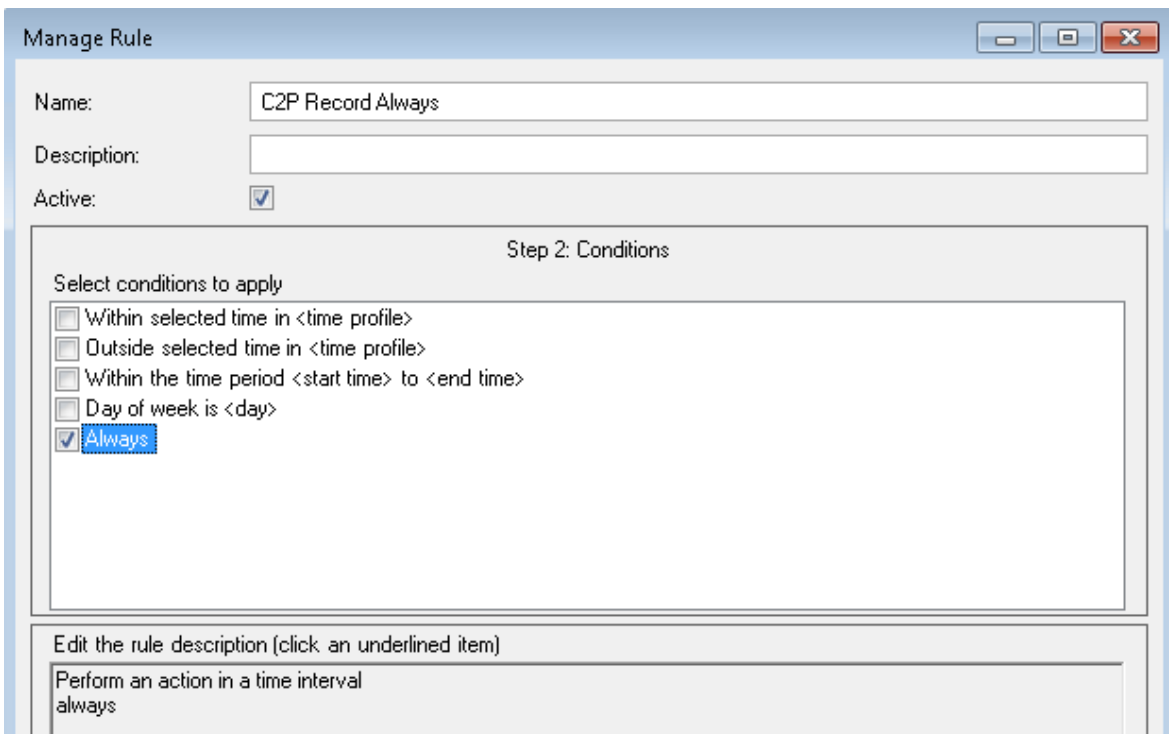
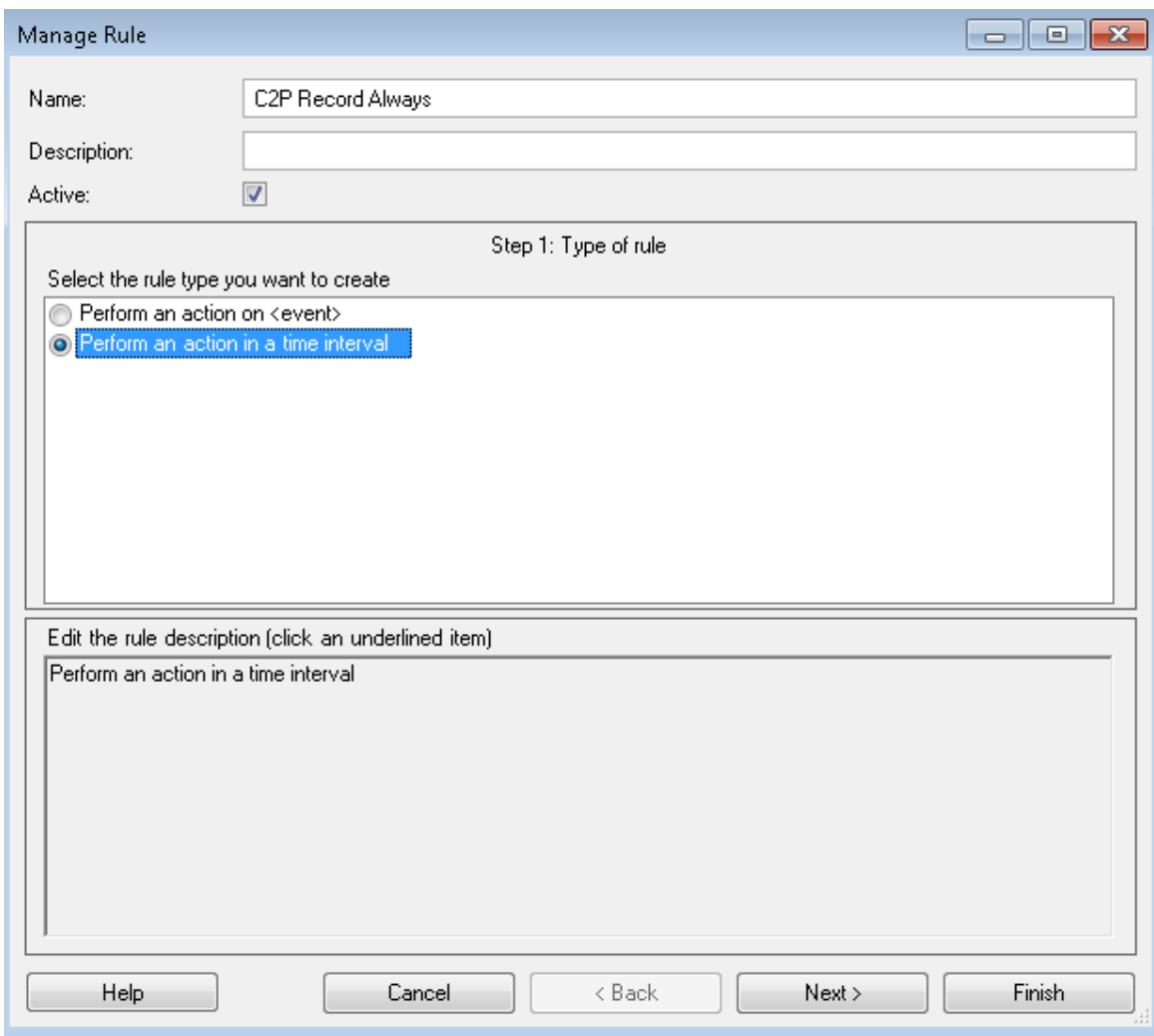

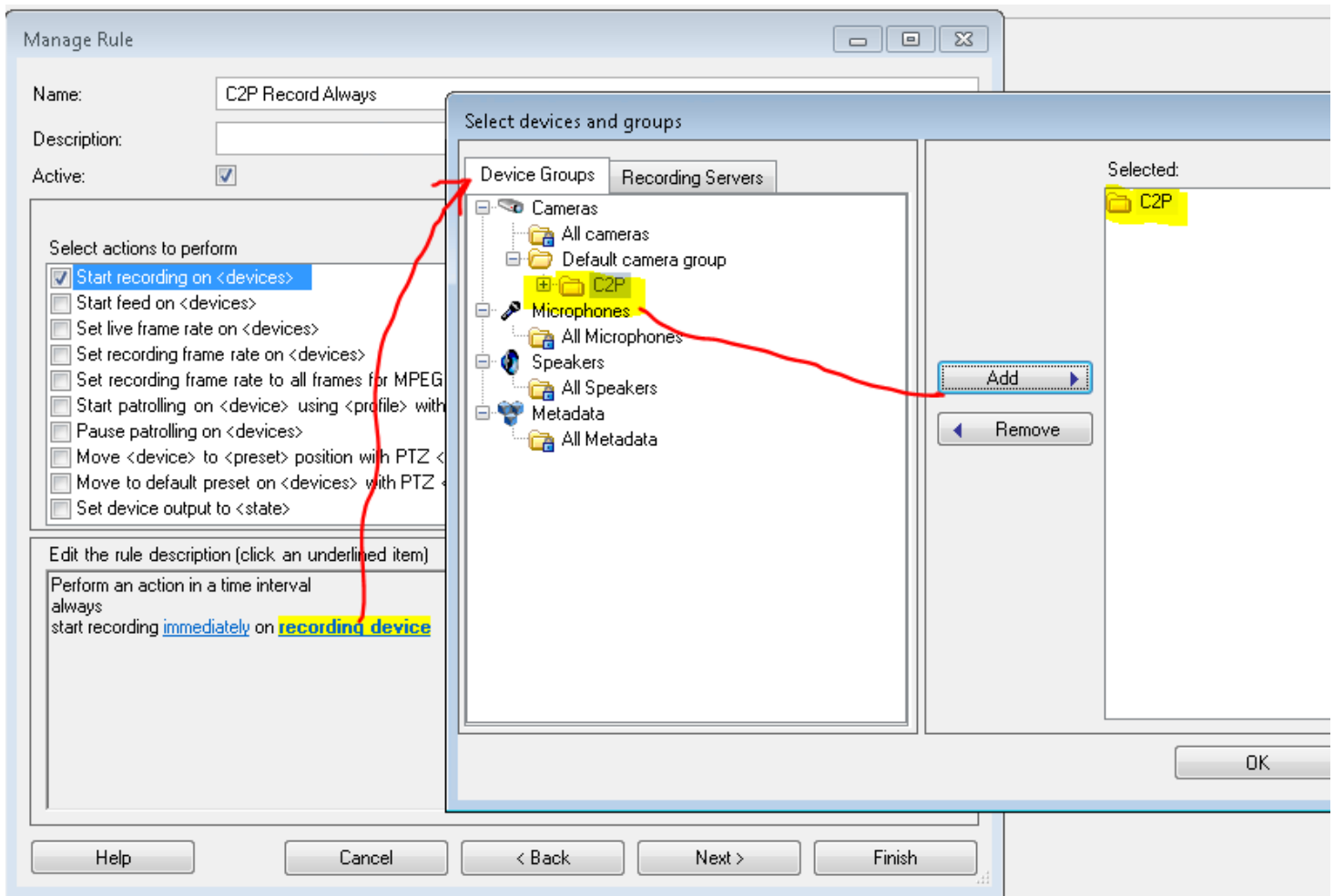

Done, this is your Rule below

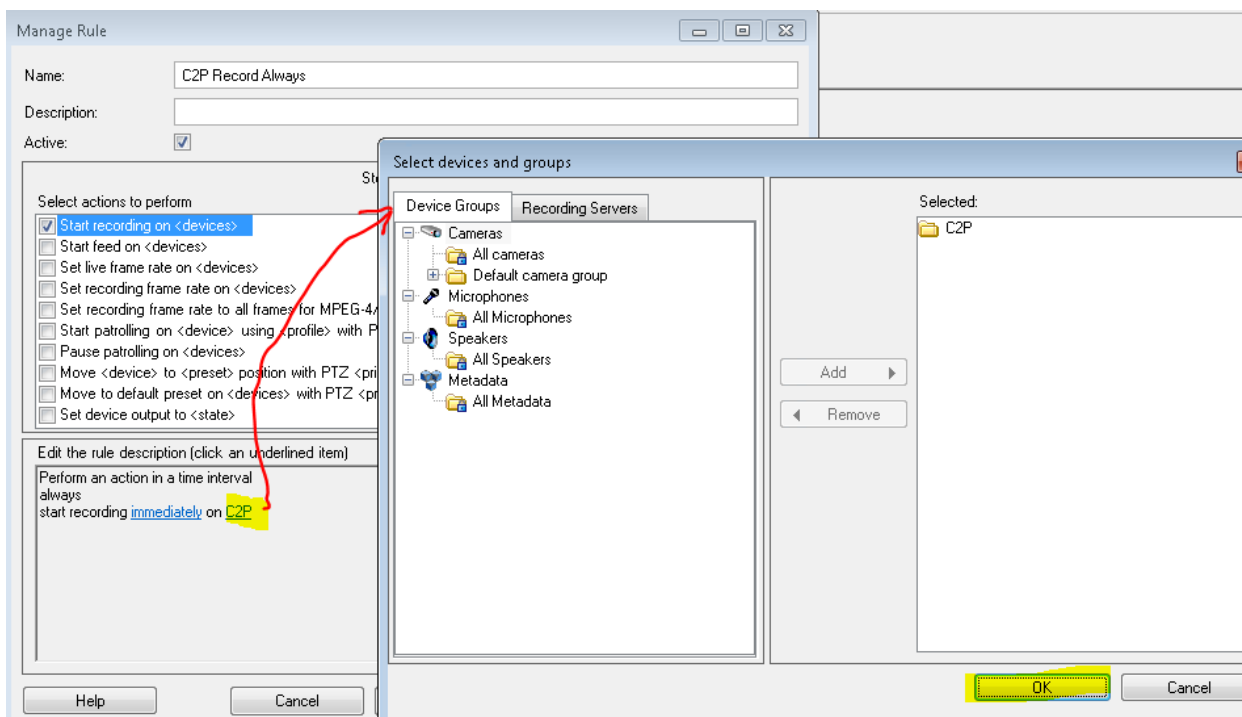

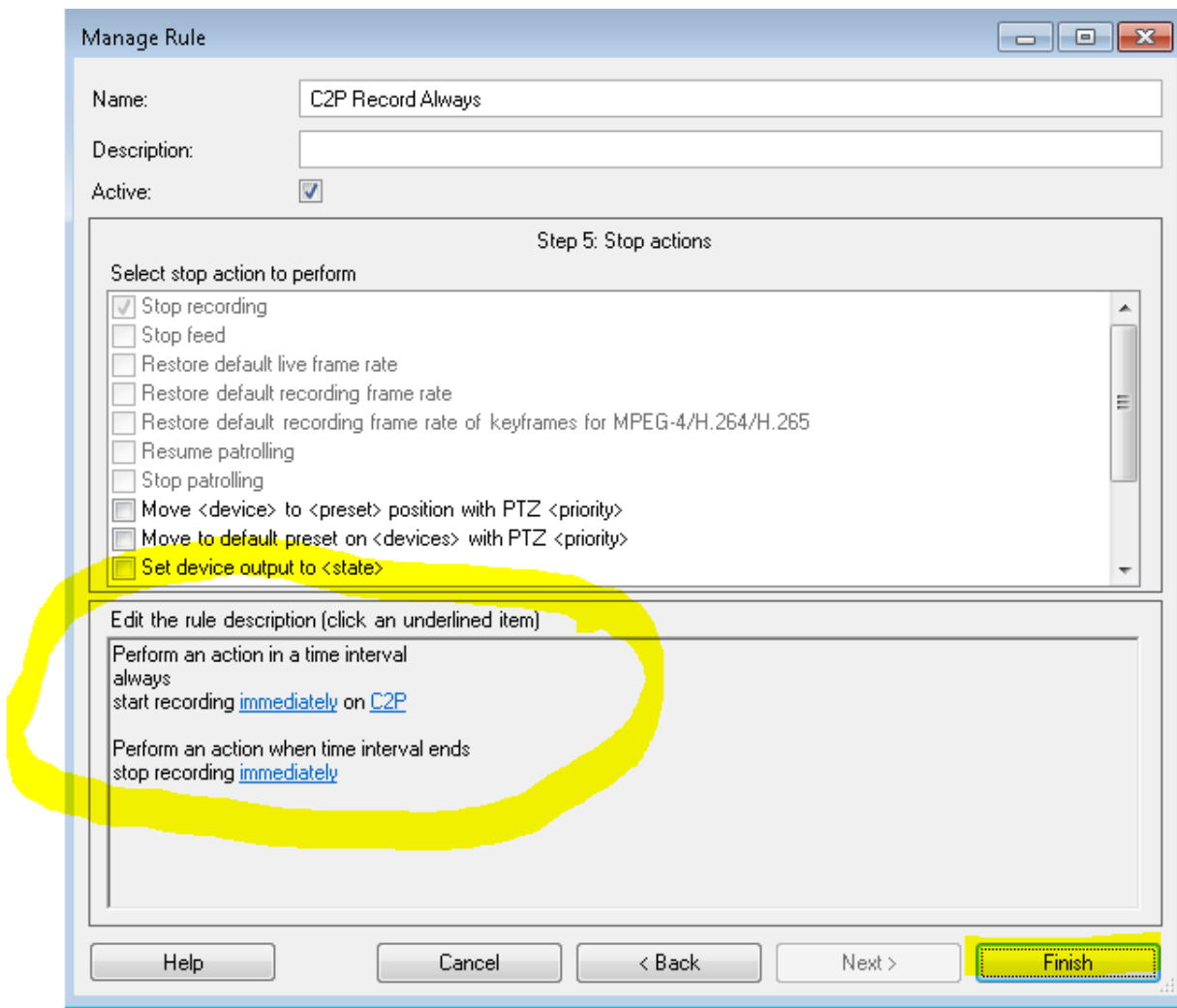

The C2P cameras should be ready to go now.



Shipping & Receiving



- Integrate your asset tracking /barcode system with XProtect establishing a Unified Security monitoring and analysis platform making your video management system (VMS) the ideal head-end.
- All asset tracking events are time synchronized with all area surveillance video.
- Real-time onscreen asset tracking activity, plus real time charting of specific events.
- User defined real-time onscreen event annotation as well as Email and SMS alerts.
- Powerful Hypermedia Search Engine links all text received with all stored surveillance video.
- Export spreadsheet reports as CSV files and display reports onscreen as a camera view.
- Report Manager spreadsheet provides a simple one-click selection of an event bringing up detailed parameters of the event all time synchronized with the video.

Hypermedia Search™

From: 01/26/2019 23:59 To: 01/27/2019 23:59 [Add Parameter] [Spreadsheet]

| View Event | Date | Reader ID | Scan Code |
|-------------------------|--------------------|-----------|-----------------------|
| [Show Cameras] [Expand] | 18:46:55 1/27/2019 | 127.0.0.1 | JJD01460003124199110 |
| [Show Cameras] [Expand] | 18:46:45 1/27/2019 | 127.0.0.1 | JJD01460003124199110 |
| [Show Cameras] [Expand] | 18:46:34 1/27/2019 | 127.0.0.1 | JJD01460003124199110 |
| [Show Cameras] [Expand] | 18:46:24 1/27/2019 | 127.0.0.1 | JJD014600002695028353 |
| [Show Cameras] [Expand] | 18:46:14 1/27/2019 | 127.0.0.1 | JJD014600002695028352 |
| Currently Displayed | | | |
| [Show Cameras] [Expand] | 18:46:04 1/27/2019 | 127.0.0.1 | JJD014600002695028353 |

HAZARDOUS MATERIAL Alarm

Scanned: JJD014600002695028352
 Package Identified as HAZARDOUS
 Handle with Care

Select search parameter from drop down tab.

Qualify your search with equal to, not equal to, contains, etc.

Setup your spreadsheet columns using either default settings or add or delete columns.

Select Download to export data in CSV format to a spreadsheet where you can create a visual representation of the data.

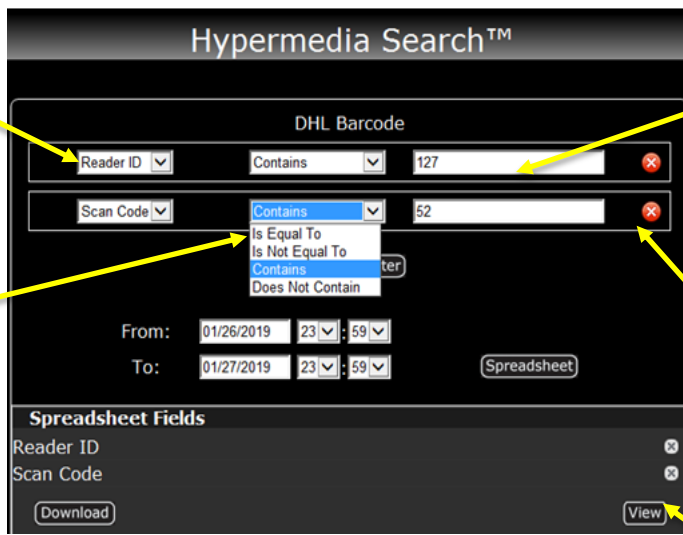

Use full or partial keywords from metadata to setup the search.

Filter your search by adding multiple keywords.

Once your search parameters are defined select view to present results in table.

Add new column headings to your spreadsheet using drop down menu.

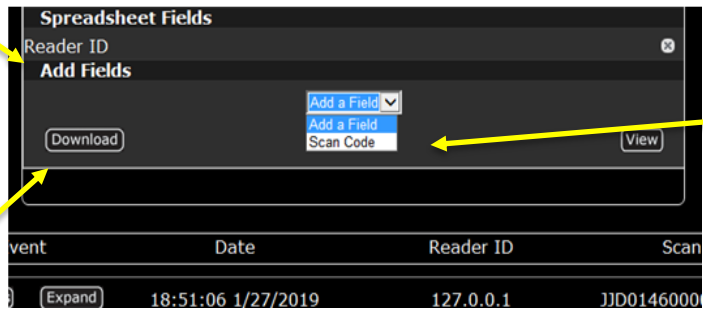

Add additional camera views during your forensic investigations.

Barcode Scan count

Use Snap Shot to print video and text images for your incident reports.

Add your notes to spreadsheet

DHL Report Entries: 888

| Timestamp | ReaderID | ScanCode | ReportComment |
|----------------------|-----------|-----------------------|---------------|
| 1/27/2019 9:14:32 PM | 127.0.0.1 | JJD014600003124199110 | |
| 1/27/2019 9:14:22 PM | 127.0.0.1 | JJD014600002695028353 | |
| 1/27/2019 9:14:12 PM | 127.0.0.1 | JJD014600002695028352 | |
| 1/27/2019 9:14:02 PM | 127.0.0.1 | JJD014600002695028353 | |
| 1/27/2019 9:13:52 PM | 127.0.0.1 | JJD014600003124199110 | |

Integrating IP Data with Video Surveillance



Contact Information

ConvergenceTP, Inc.

42 Lake Ave Extension #110

Danbury, CT 06811 USA

Website www.c2p.com

Sales Support Sales@c2p.com 800.252.6840 x 1

Technical Support Support@c2p.com 800.252.6840 x 2